

= MAIN =
32" x 26"
A IC 800
FLI8532
(CORTEZ)
B

= INITIAL (32") =
JACK_BD
MP DATA (8-1DR)

APPLIED MODEL
32LX2R, 32LP1R, 37LP1R, 42LP1R

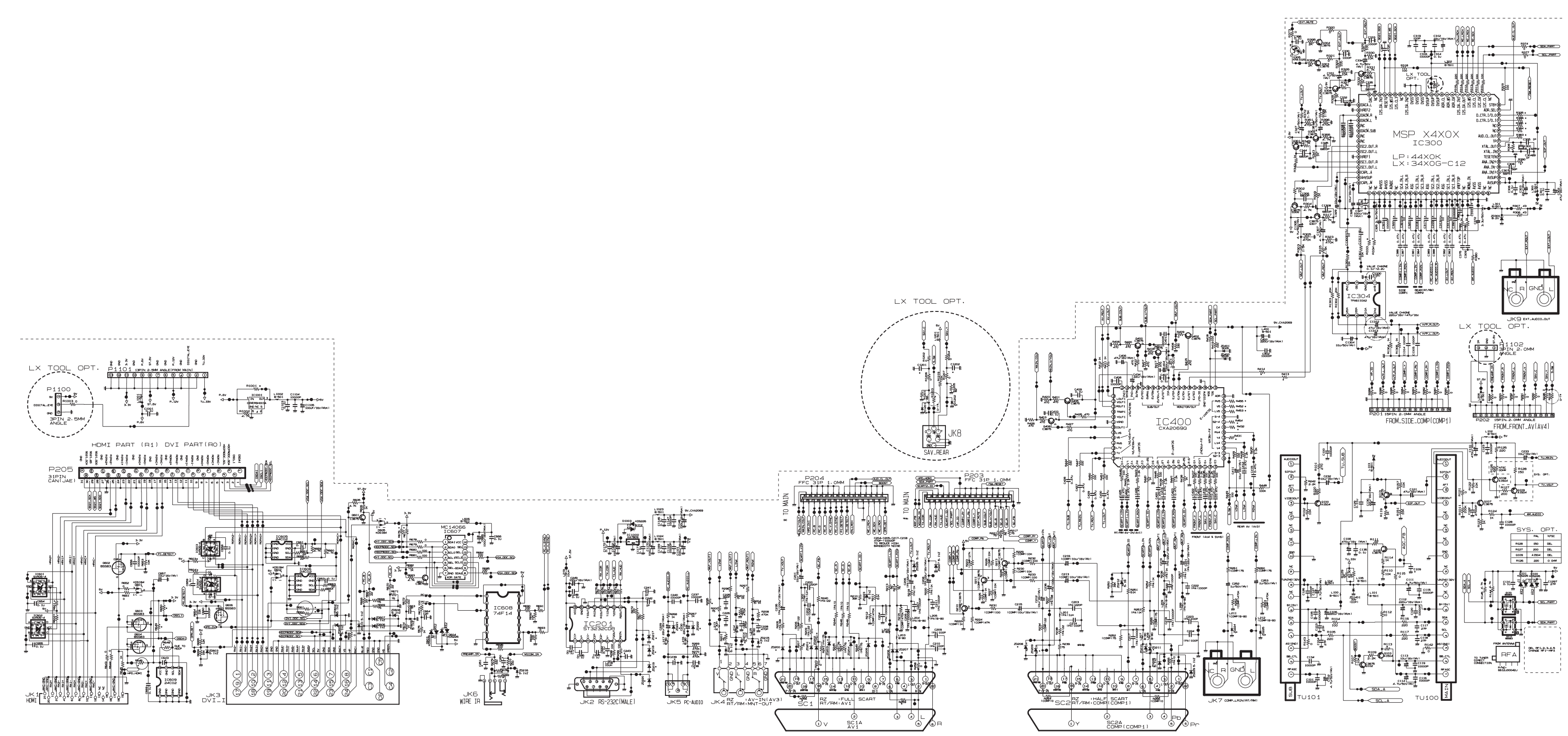

= JACK_BD =
26" ONLY
LP & MP PCB DATA

SIDE_COMP

TORNADO
INITIAL-32
LX TOOL ALSO
USE THIS CIRCUIT

LP TOOL FINAL

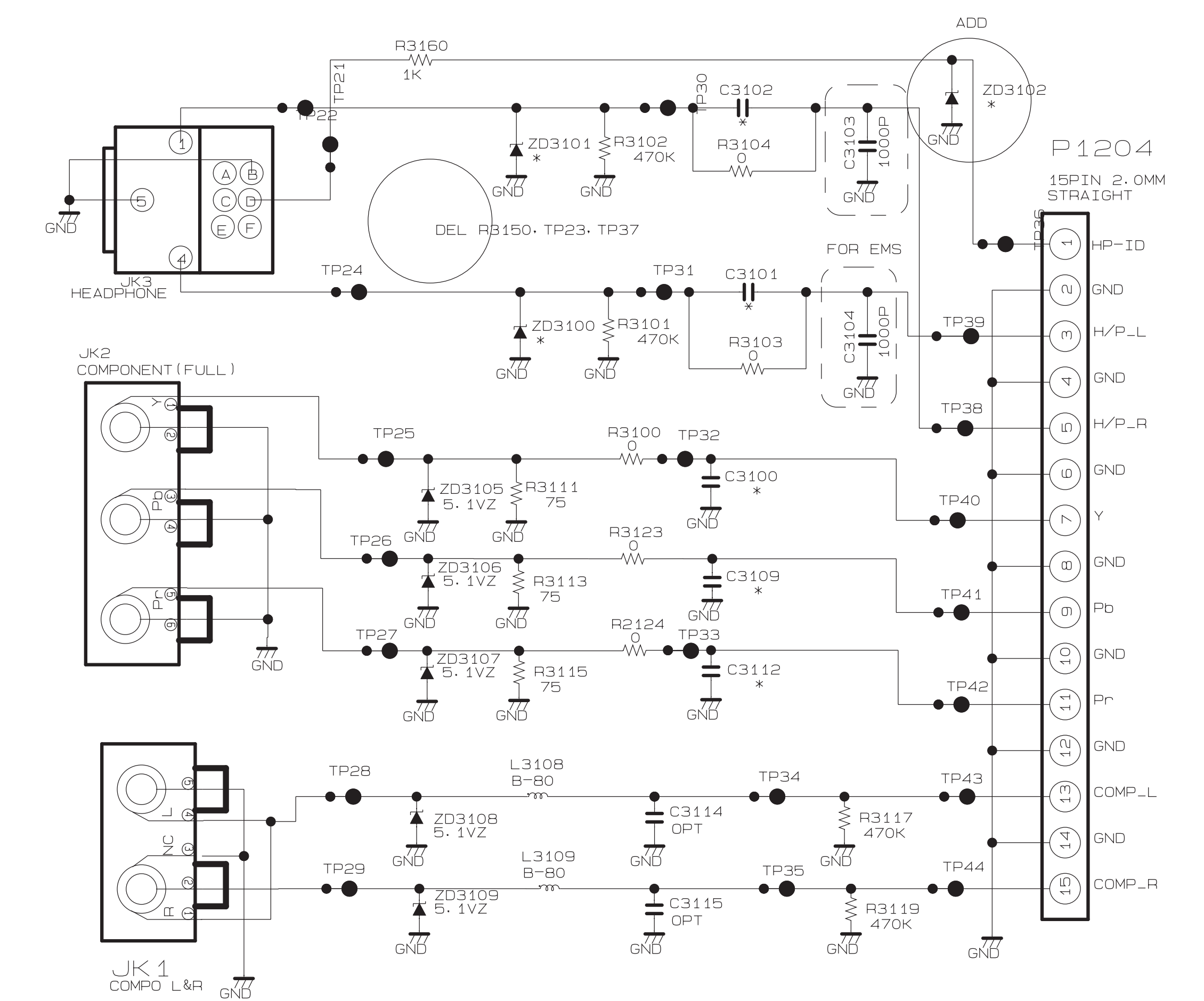
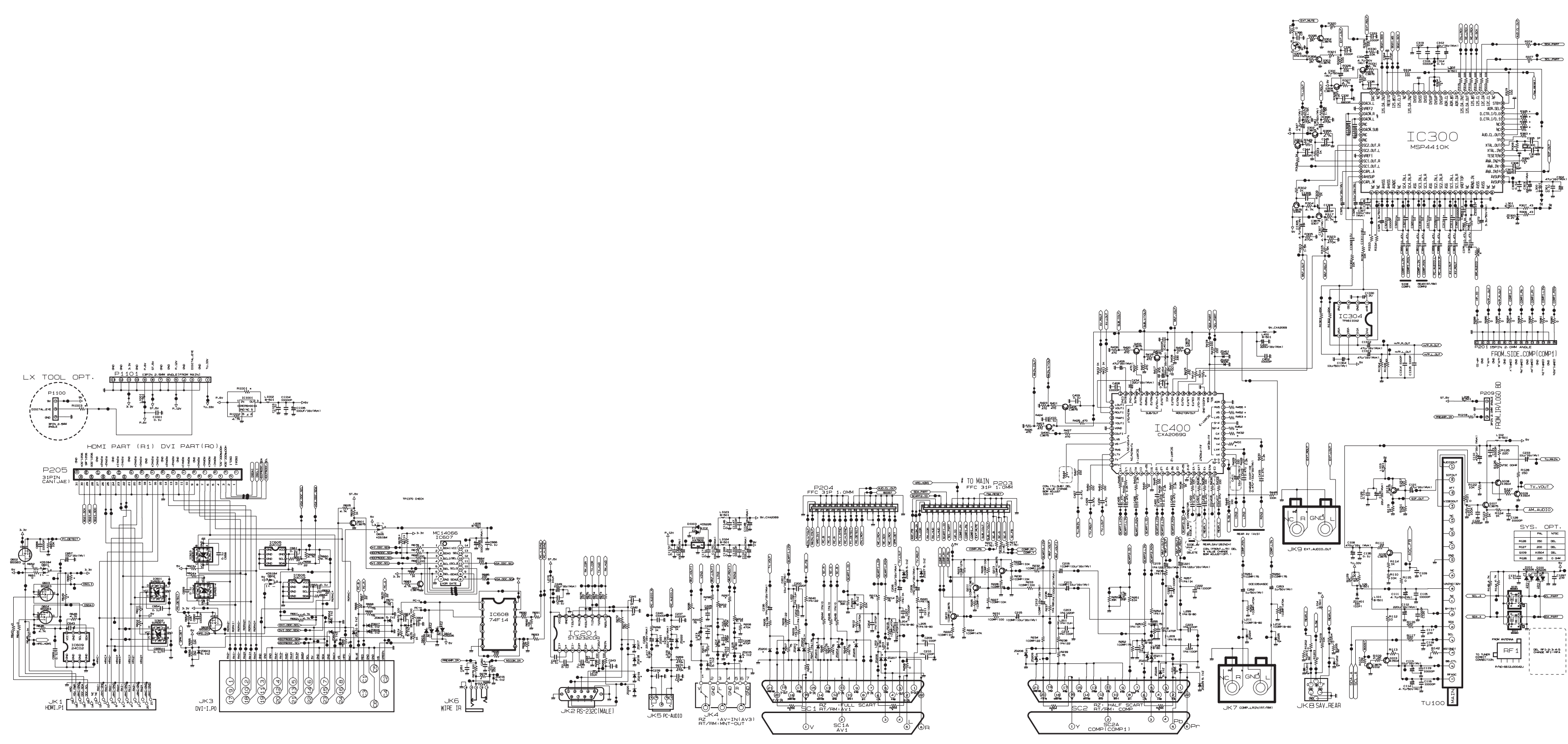

INDEX
TORNADO_32LP1R-2E
32LP1R-2E

LED ASSY

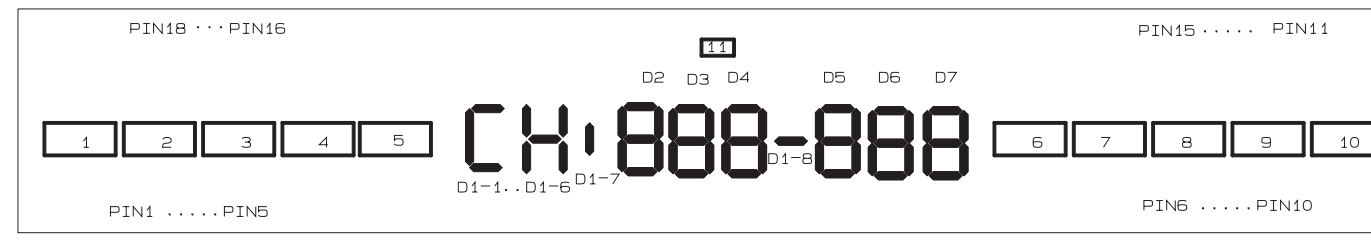
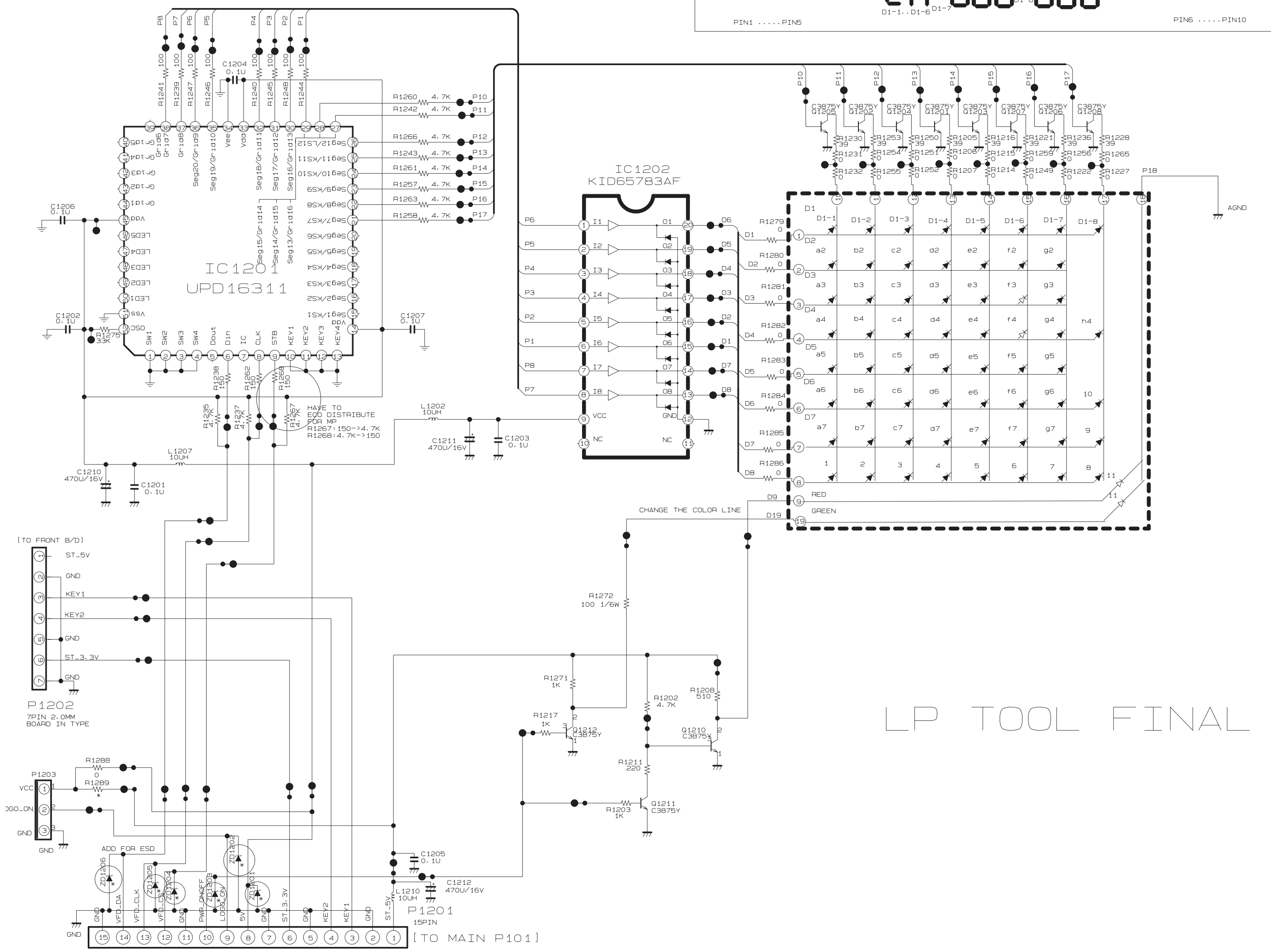

KEY_FRONT
TORNADO
INITIAL_32INCH

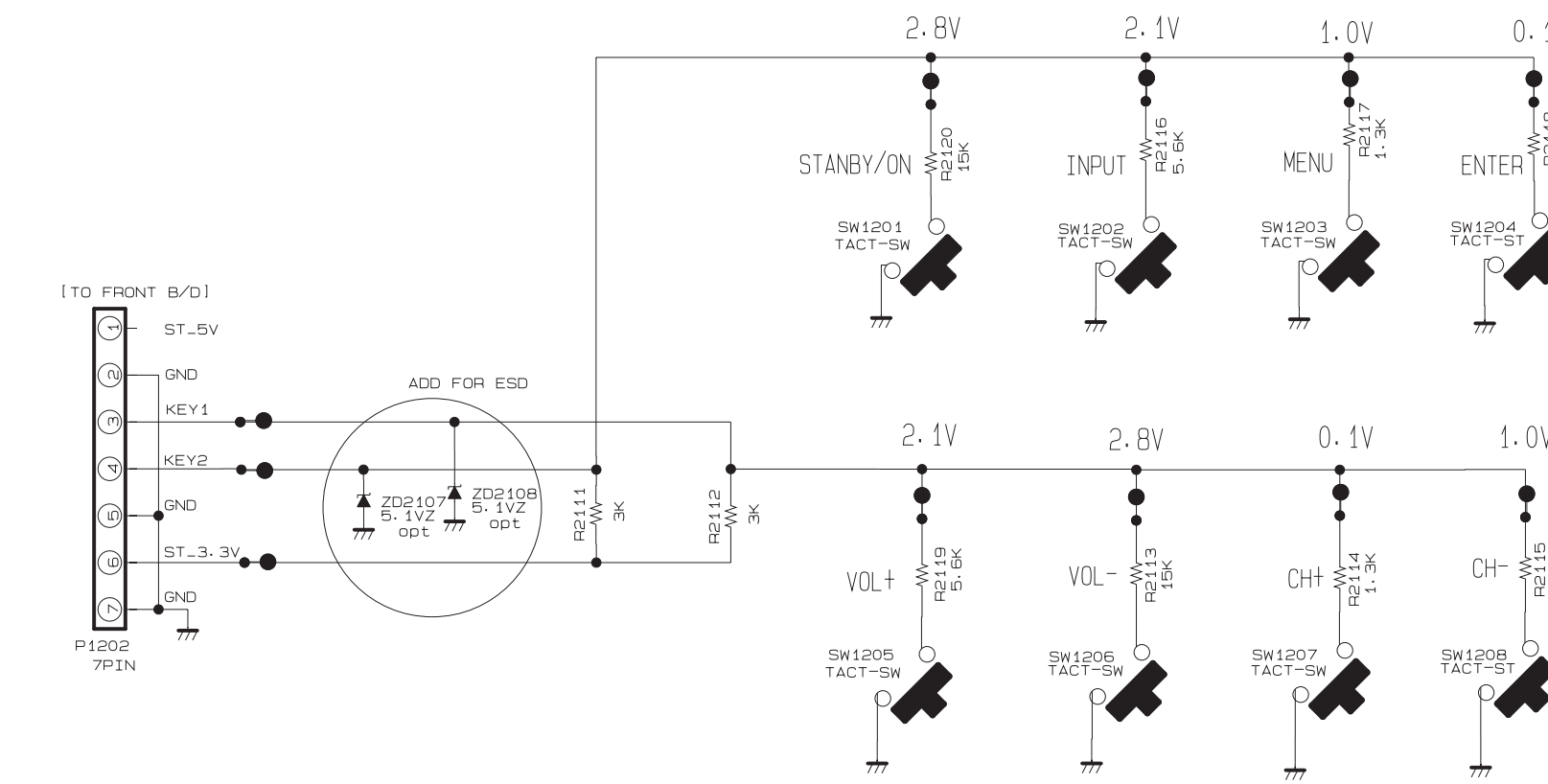

LP TOOL FINAL

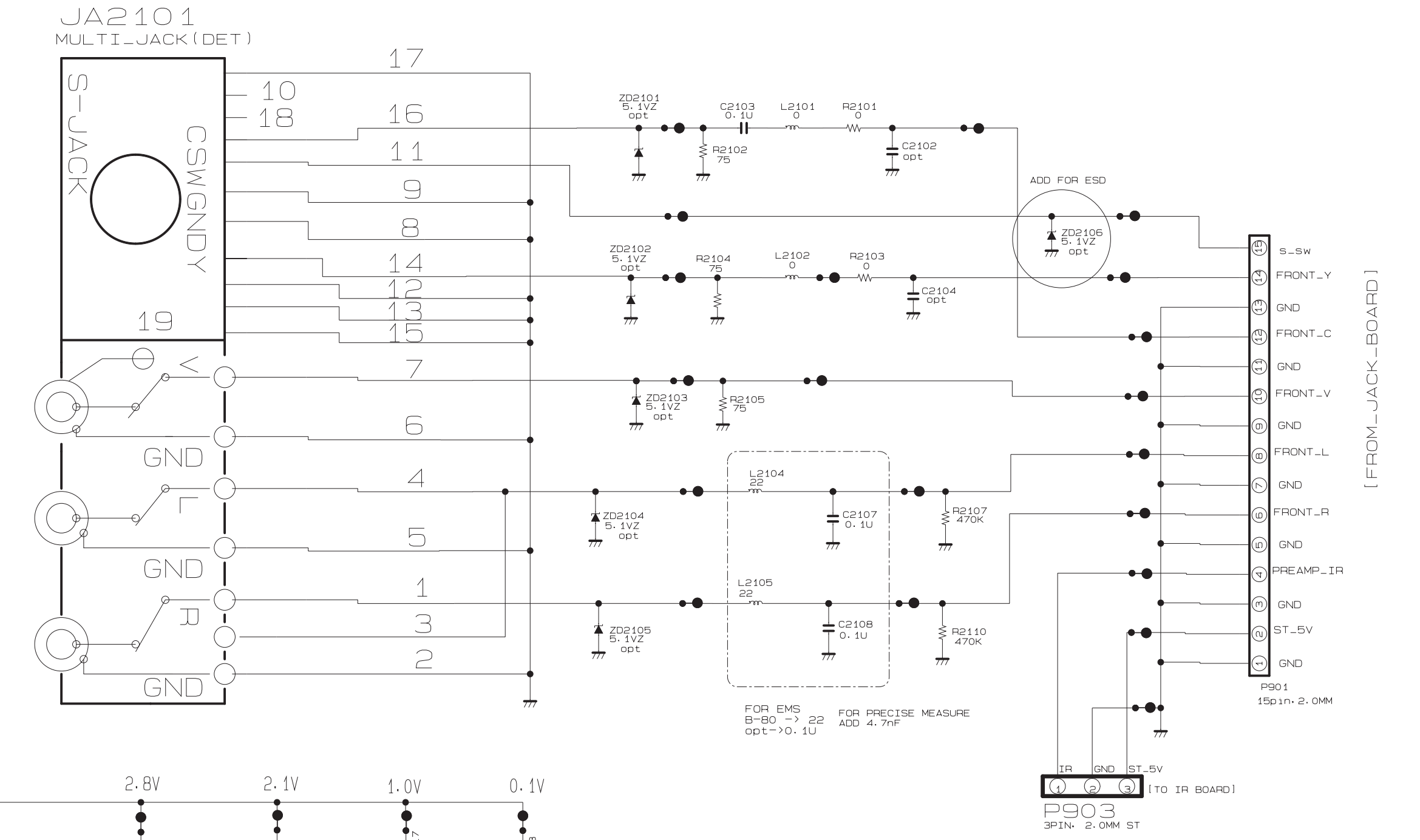

LP TOOL FINAL

LOGO BD

FOR TORNADO
32INCH

LP TOOL FINAL

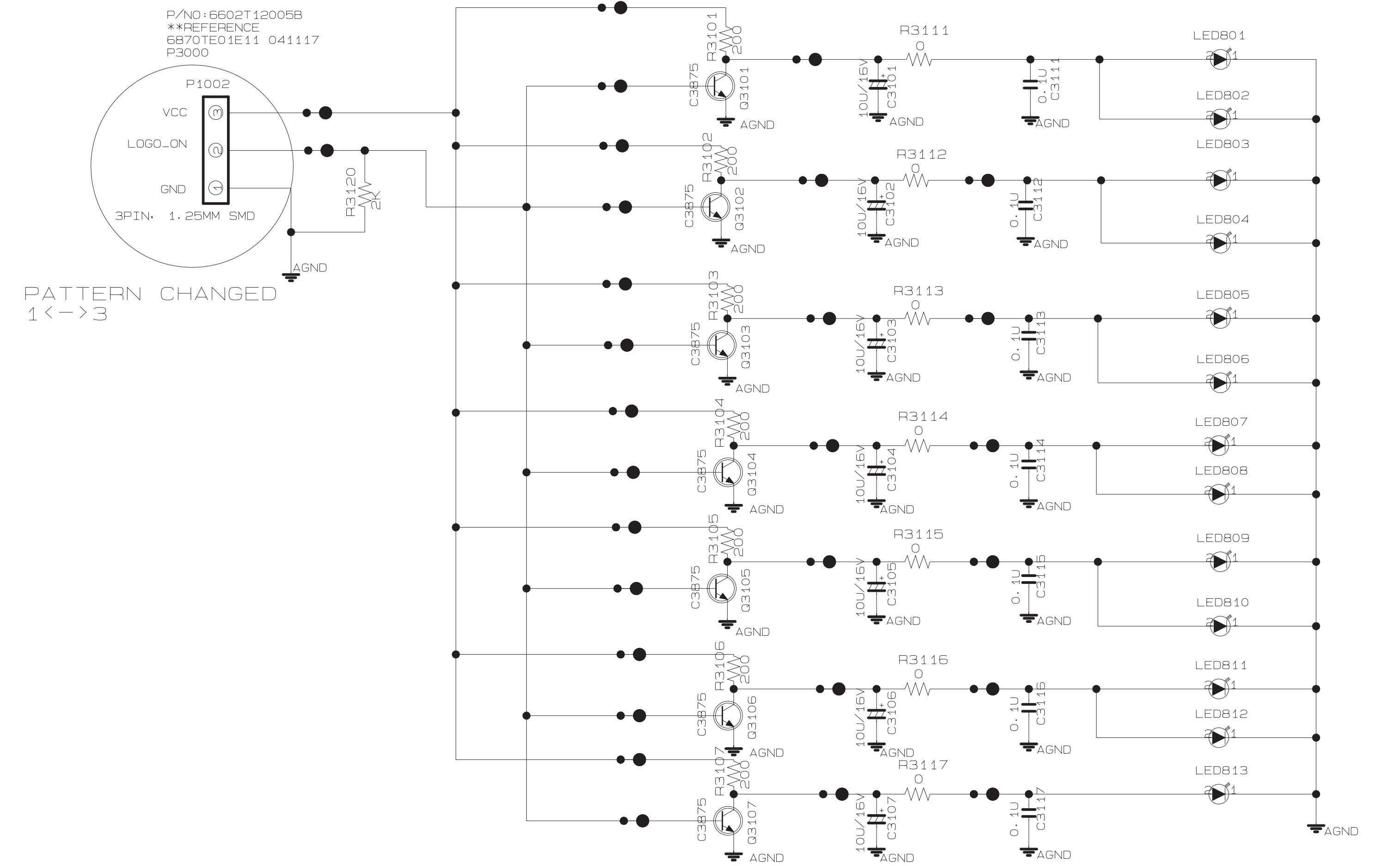

IR BOARD

32LP1R-2E
TORNADO

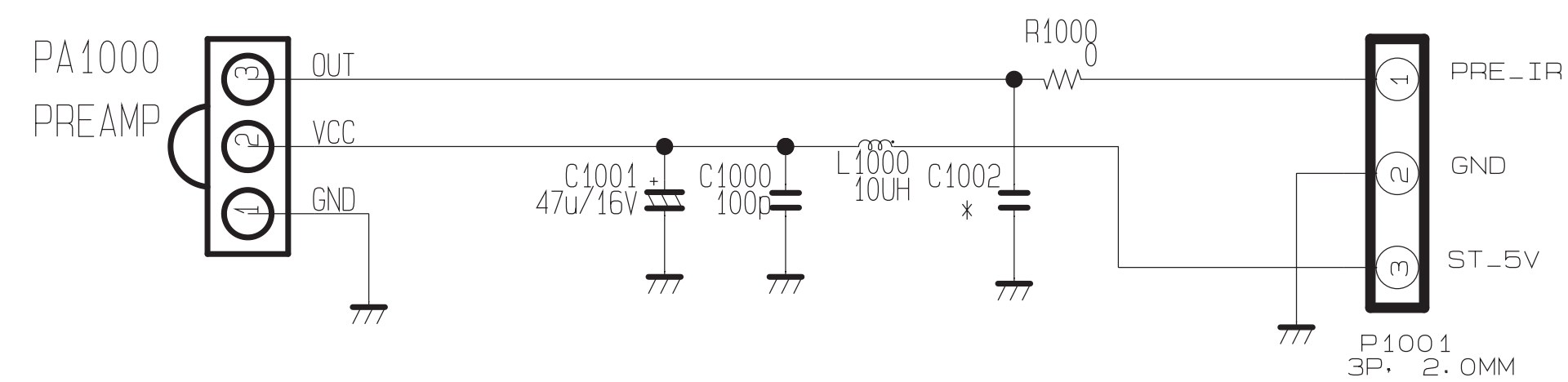

IR_LOGO BD
FOR TORNADO

32.26 LX TOOL

MODIFY FOR LP

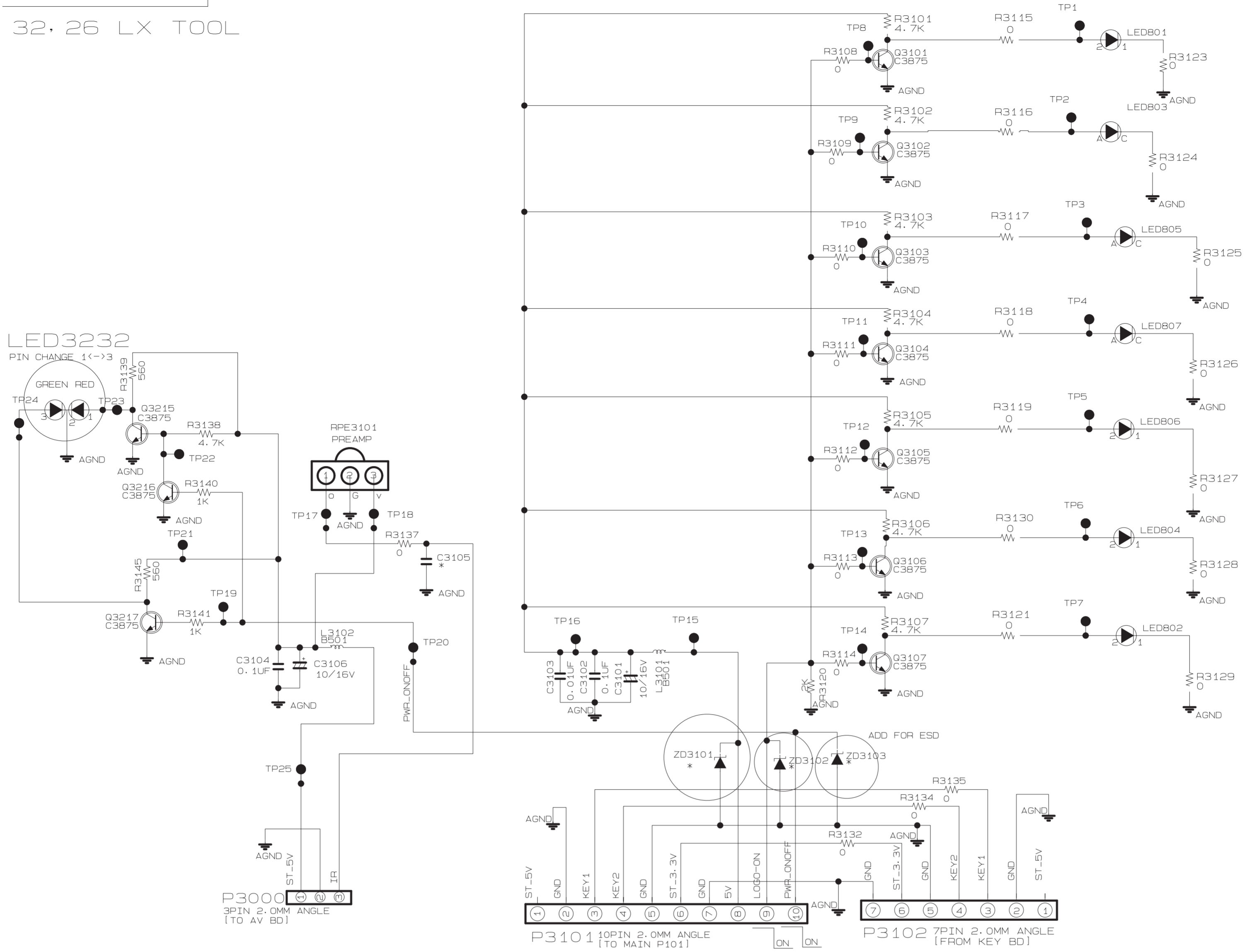

KEY BD
FOR TORNADO

32.26 LX TOOL

MODIFY FOR LP

P1202
7PIN 2.0MM ANGLE
[TO IR_LOGO B/D]

