

AN12942B

Audio signal processing IC for notebook PC

■ Overview

AN12942B is an one-chip IC for the stereo speakers which can output 1 W by 8 Ω, headphone amplifiers, line amplifiers, and electronic volumes.

The AGC circuit is built-in to prevent the resonance or the vibration by the speaker's energy and the clipping distortion what is called "broken up sound".

Also the AN12942B is built-in power saving on/off function automatically detecting input signal to save the power of speaker amplifier.

■ Features

- Speaker amplifier
1 W × 2-channel: 8 Ω, $V_{CC} = 5\text{ V}$
- Built-in AGC circuit
Prevention of the resonance or the vibration due to the speaker and the clipping distortion by AGC at excessive input signal (with AGC on/off switch).
- Built-in automatic power saving function.
It detects input signals and switches on/off (with the on/off switch for the auto power saving).
- Built-in headphone amplifier and line amplifier

■ Applications

- Notebook PC

■ Package

- Dual surface implementing package (HSOP056-P-0300A)

■ Type

- Silicon monolithic bipolar IC

■ Application circuit example

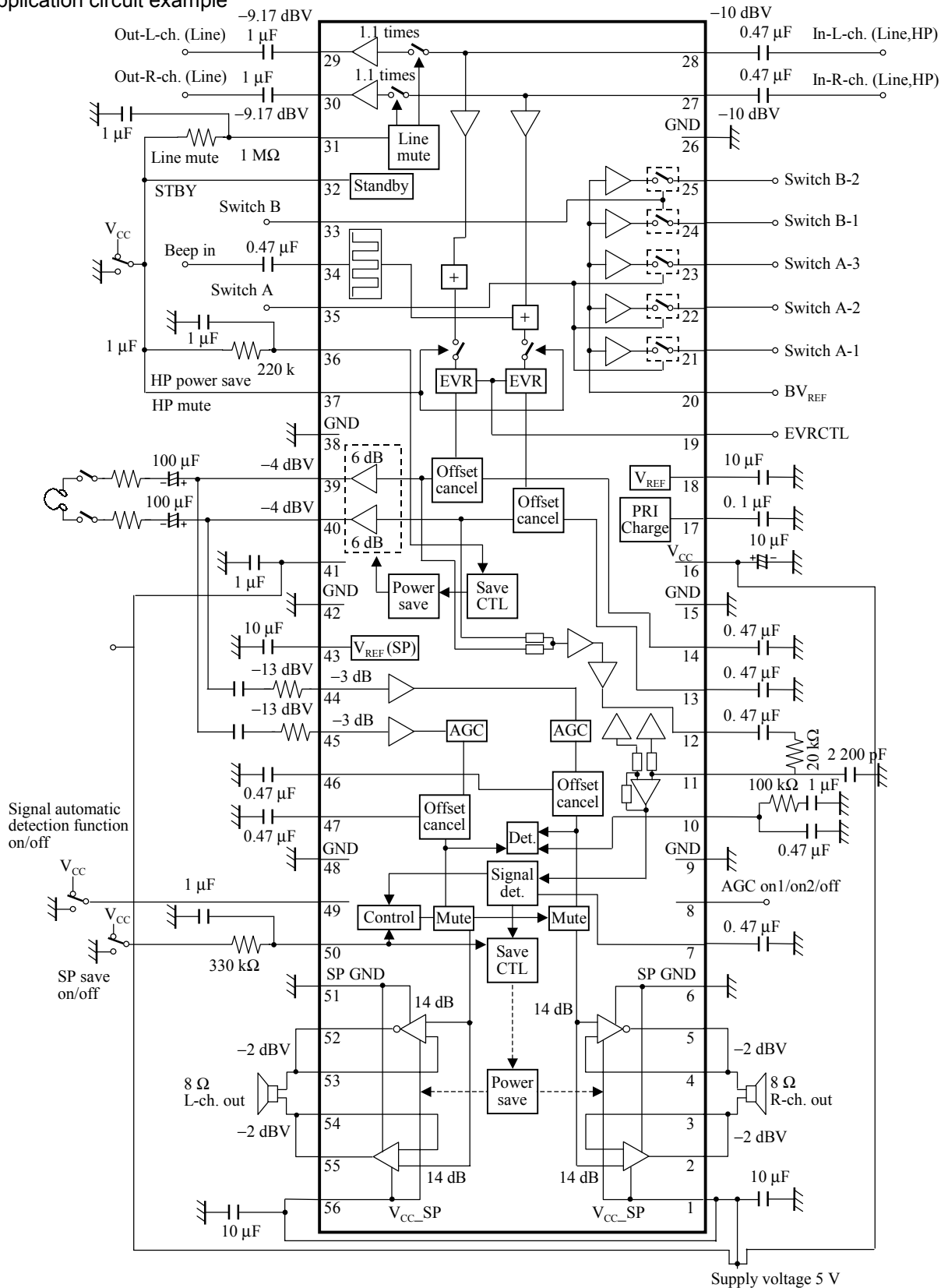

■ Pin Descriptions

Pin No.	Pin name	Type	Description
1	V _{CC_SP}	V _{CC}	V _{CC_SP} R-channel
2	SP_OUT_R+	Output	Speaker amplifier R-channel positive phase output (+)
3	SP_OUT_R+	Output	Speaker amplifier R-channel positive phase output (+)
4	SP_OUT_R-	Output	Speaker amplifier R-channel negative phase output (-)
5	SP_OUT_R-	Output	Speaker amplifier R-channel negative phase output (-)
6	GND_SP	GND	GND_SP R-channel
7	DETECT_CAP	Input	Demodulation pin for signal automatic detection
8	AGC_LV	TTL input	AGC-on level control
9	GND	GND	GND
10	AGC_CAP	Input	AGC demodulation pin
11	DETECT_IN	Input	Signal input for signal automatic detection
12	DAMP_OUT	Output	Signal automatic detection mix amplifier output
13	OFFSET_HPR	Input	Offset cancel pin for headphone R-channel
14	OFFSET_HPL	Input	Offset cancel pin for headphone L-channel
15	GND	GND	GND
16	V _{CC}	V _{CC}	V _{CC}
17	PRI_V	Input	PRI-charge level pin
18	V _{REF_IN}	Input	V _{REF}
19	EVR_CTL	TTL input	EVR control for speaker and headphone
20	BV _{REF}	Input	Bias in
21	Switch A-1	Output	Switch A-1
22	Switch A-2	Output	Switch A-2
23	Switch A-3	Output	Switch A-3
24	Switch B-1	Output	Switch B-1
25	Switch B-2	Output	Switch B-2
26	GND	GND	GND
27	INPUT_R	Input	R-channel input
28	INPUT_L	Input	L-channel input
29	LINEOUT_L	Output	Line L-channel output
30	LINEOUT_R	Output	Line R-channel output
31	LINE_MUTE	TTL input	Line mute on/off control
32	STANDBY	TTL input	Standby on/off control
33	Switch B	TTL input	Switch B
34	BEEP_IN	Input	Input for beep signal

■ Pin Descriptions (continued)

Pin No.	Pin name	Type	Description
35	Switch A	TTL input	Switch A
36	HP_SAVE	TTL input	Headphone power save control
37	HP_MUTE	TTL input	Headphone mute on/off control
38	GND	GND	GND
39	HP_OUT_L	Output	Headphone amplifier L-channel output
40	HP_OUT_R	Output	Headphone amplifier R-channel output
41	V _{CC}	V _{CC}	V _{CC}
42	GND	GND	GND
43	V _{REF_SP}	Input	V _{REF_SP}
44	SP_IN_R	Input	Speaker amplifier R-channel input
45	SP_IN_L	Input	Speaker amplifier L-channel input
46	OFFSET_SPR	Input	Offset cancel pin for speaker R-channel
47	OFFSET_SPL	Input	Offset cancel pin for speaker L-channel
48	GND	GND	GND
49	DETECT_ON	TTL input	Signal automatic detection on/off control
50	SP_SAVE	TTL input	Speaker power save control
51	GND_SP	GND	GND_SP L-channel
52	SP_OUT_L-	Output	Speaker amplifier L-channel negative phase output (-)
53	SP_OUT_L-	Output	Speaker amplifier L-channel negative phase output (-)
54	SP_OUT_L+	Output	Speaker amplifier L-channel positive phase output (+)
55	SP_OUT_L+	Output	Speaker amplifier L-channel positive phase output (+)
56	V _{CC_SP}	V _{CC}	V _{CC_SP} L-channel

■ Absolute Maximum Ratings

A No.	Parameter	Symbol	Rating	Unit	Note
1	Supply voltage	V_{CC}	5.75	V	*1
		V_{CC_SP}	5.75		
2	Supply current	I_{CC}	—	A	—
3	Power dissipation	P_D	517	mW	*2
4	Storage temperature	T_{stg}	-55 ~ +150	°C	*3
5	Operating ambient temperature	T_{opr}	-20 ~ +75	°C	*3

Note) *1: The values under the condition not exceeding the above absolute maximum ratings and the power dissipation.

*2: When using this IC, referring to the technical data in page 17, observe the power dissipation characteristic curve.

Be sure to use the IC so that the power dissipation of the IC without heat sink will not exceed 517 mW at $T_a = 75^\circ\text{C}$.

*3: Except for the operating ambient temperature and storage temperature, all ratings are for $T_a = 25^\circ\text{C}$.

■ Operating Supply Voltage Range

Parameter	Symbol	Range	Unit	Note
Operating supply voltage range	V_{CC}	4.50 ~ 5.50	V	—
	V_{CC_SP}	4.50 ~ 5.50		*

Note) *: The values under the condition not exceeding the above absolute maximum ratings and the power dissipation.

■ Electrical Characteristics at $V_{CC} = 5.0\text{ V}$, $V_{CC_SP} = 5.0\text{ V}$

 Note) $T_a = 25^\circ\text{C} \pm 2^\circ\text{C}$ unless otherwise specified.

B No.	Parameter	Symbol	Test circuits	Conditions	Limits			Unit	Note
					Min	Typ	Max		
Circuit current									
1	Circuit current 1A at non-signal (V_{CC_SP})	IT1A	1	$V_{CC} = 5.00\text{ V}$, at non-signal, at automatic distinction: on	—	35	70	μA	—
2	Circuit current 2A at non-signal (V_{CC})	IT2A	1		—	20.0	27.0	mA	—
3	Circuit current 1B at non-signal (V_{CC_SP})	IT1B	1	$V_{CC} = 5.00\text{ V}$, at non-signal, SP and HP power save: off, at automatic distinction	—	9.3	18.6	mA	—
4	Circuit current 2B at non-signal (V_{CC})	IT2B	1		—	21.0	28.0	mA	—
5	Circuit current 1C at non-signal (V_{CC_SP})	IT1C	1	$V_{CC} = 5.00\text{ V}$, at non-signal, at automatic distinction: off, SP and HP power save: on	—	35	70	μA	—
6	Circuit current 2C at non-signal (V_{CC})	IT2C	1		—	14.0	19.0	mA	—
7	Standby current 1 at non-signal (V_{CC_SP})	IST1	1	$V_{CC} = 5.00\text{ V}$, at standby mode	—	10	50	μA	—
8	Standby current 2 at non-signal (V_{CC})	IST2	1		—	0.1	50	μA	—
Speaker amplifier ($R_L = 8\ \Omega$): Speaker_input (pin 44, pin 45) → Speaker_output (pin 2 to pin 5, pin 52 to pin 55)									
9	Output level L-channel	VSPL	1	$V_{IN} = -13.0\text{ dBV}$, $f = 1\text{ kHz}$, $R_L = 8\ \Omega$	2.0	4.0	6.0	dBV	—
10	Output level R-channel	VSPR	1		2.0	4.0	6.0	dBV	—
11	Output distortion L-channel	TH _S L	1	$V_{IN} = -13.0\text{ dBV}$, $f = 1\text{ kHz}$, $R_L = 8\ \Omega$, to THD fifth	—	0.04	0.5	%	—
12	Output distortion R-channel	TH _S R	1		—	0.04	0.5	%	—
13	Maximum output electric power L-channel	VMAXSL	1	$V_{IN} = 1\text{ kHz}$, THD = 1%, $R_L = 8\ \Omega$,	0.7	0.88	—	W	—
14	Maximum output electric power R-channel	VMAXSR	1		0.7	0.88	—	W	—
15	Output noise L-channel	VNSL	1	$R_g = 1\text{ k}\Omega$, $R_L = 8\ \Omega$, A curve filter	—	-76	-67	dBV	—
16	Output noise R-channel	VNSR	1		—	-76	-67	dBV	—
17	Channel balance	CHBS	1	$V_{IN} = -13.0\text{ dBV}$, $f = 1\text{ kHz}$, $R_L = 8\ \Omega$	-1	0	1	dB	—
18	Cross talk in L-channel	CTLSLR	1	$V_{IN} = -13.0\text{ dBV}$, $f = 1\text{ kHz}$, $R_L = 8\ \Omega$, A curve filter	70	76	—	dB	—
19	Cross talk in R-channel	CTLSRL	1		70	76	—	dB	—
Headphone amplifier ($R_L = 32\ \Omega$): L-channel, R-channel_input (pin 28, pin 27) → Headphone_output (pin 39, pin 40)									
20	Output level L-channel	VHPL	1	$V_{IN} = -10.0\text{ dBV}$, $R_L = 32\ \Omega$, Vol = 3.3 V (max), $f = 1\text{ kHz}$	-5.0	-4.0	-3.0	dBV	—
21	Output level R-channel	VHPR	1		-5.0	-4.0	-3.0	dBV	—
22	Channel balance	CHBH	1	$V_{IN} = -10.0\text{ dBV}$, $R_L = 32\ \Omega$, Vol = 3.3 V (max), $f = 1\text{ kHz}$, R-ch./L-ch. difference	-1.0	0.0	1.0	dB	—

■ Electrical Characteristics at $V_{CC} = 5.0 \text{ V}$, $V_{CC-SP} = 5.0 \text{ V}$ (continued)

 Note) $T_a = 25^\circ\text{C} \pm 2^\circ\text{C}$ unless otherwise specified.

B No.	Parameter	Symbol	Test circuits	Conditions	Limits			Unit	Note
					Min	Typ	Max		
Headphone Amplifier ($R_L = 32 \Omega$) (continued): L-channel, R-channel_input (pin 28, pin 27) → Headphone_output (pin 39, pin 40)									
23	Output distortion L-channel	THHL	1	$V_{OUT} = -14 \text{ dBV}$, $R_L = 32 \Omega$ $V_{ol} = 3.3 \text{ V (max)}$, $f = 1 \text{ kHz}$	—	0.03	0.1	%	—
24	Output distortion R-channel	THHR	1		—	0.03	0.1	%	—
25	Maximum input level L-channel	VMAHIL	1	THD = 1%, $R_L = 10 \text{ k}\Omega$ $V_{ol} = 1.65 \text{ V (typ)}$, $f = 1 \text{ kHz}$	0.0	6.0	—	dBV	—
26	Maximum input level R-channel	VMAHIR	1		0.0	6.0	—	dBV	—
27	Maximum output level L-channel	VMAHOL	1	THD = 1%, $R_L = 10 \text{ k}\Omega$ $V_{ol} = 3.3 \text{ V (max)}$, $f = 1 \text{ kHz}$	0.0	2.8	—	dBV	—
28	Maximum output level R-channel	VMAHOR	1		0.0	2.8	—	dBV	—
29	Output noise L-channel	VNHL	1	$R_g = 1 \text{ k}\Omega$, A curve filter	—	-94	-79	dBV	—
30	Output noise R-channel	VNHR	1		—	-94	-79	dBV	—
31	Cross talk in L-channel	CTLHLR	1	$V_{IN} = -10 \text{ dBV}$, $R_L = 32 \Omega$ $f = 10 \text{ kHz}$, A curve filter	60	70	—	dB	—
32	Cross talk in R-channel	CTLHRL	1		60	70	—	dB	—
33	Mute attenuation quantity L-channel	VMUHL	1	$V_{IN} = -10 \text{ dBV}$, $R_L = 32 \Omega$ $f = 1 \text{ kHz}$, A curve filter	70	90	—	dB	—
34	Mute attenuation quantity R-channel	VMUHR	1		70	90	—	dB	—
35	Beep output level L-channel	BEHL	1	$V_{IN} = 3.3 V_{PP}$, $R_L = 32 \Omega$ 1 cycle = 1 ms	0.28	0.58	—	V_{PP}	—
36	Beep output level R-channel	BEHR	1		0.28	0.58	—	V_{PP}	—
Volume part: L-channel, R-channel_input (pin 28, pin 27) → Headphone_output (pin 39, pin 40)									
37	Medium voltage gain L-channel	VOLL	1	$V_{IN} = -20 \text{ dBV}$, $f = 1 \text{ kHz}$, $V_{ol} = 1.65 \text{ V (typ)}$	-32.5	-30.0	-27.5	dBV	—
38	Medium voltage gain R-channel	VOLR	1		-32.5	-30.0	-27.5	dBV	—
39	Channel balance at the time of the medium gain	V_{CHB}	1	$V_{IN} = -20 \text{ dBV}$, $f = 1 \text{ kHz}$, $V_{ol} = 1.65 \text{ V (typ)}$ R-ch./L-ch. Difference	-2.0	0.0	2.0	dB	—
40	Volume maximum attenuation quantity L-channel	VOLNL	1	$V_{IN} = -10 \text{ dBV}$, $f = 1 \text{ kHz}$, $V_{ol} = 0.0 \text{ V (min)}$, A curve filter	70	90	—	dB	—
41	Volume maximum attenuation quantity R-channel	VOLNR	1		70	90	—	dB	—
Line amplifier part : L-channel, R-channel_input (pin 28, pin 27) → Headphone_output (pin 29, pin 30)									
42	Output level L-channel	VHLL	1	$V_{IN} = -10.0 \text{ dBV}$, $R_L = 10 \text{ k}\Omega$, $f = 1 \text{ kHz}$	-10.0	-9.2	-8.4	dBV	—
43	Output level R-channel	VHLR	1		-10.0	-9.2	-8.4	dBV	—
44	Channel balance	CHBL	1	$V_{IN} = -10.0 \text{ dBV}$, $R_L = 10 \text{ k}\Omega$, $f = 1 \text{ kHz}$, R-ch./L-ch. difference	-0.8	0.0	0.8	dB	—
45	Output distortion L-channel	THLL	1	$V_{IN} = -10.0 \text{ dBV}$, $R_L = 10 \text{ k}\Omega$, $f = 1 \text{ kHz}$	—	0.003	0.03	%	—
46	Output distortion R-channel	THLR	1		—	0.003	0.03	%	—
47	Maximum output level L-channel	VMALL5	1	THD = 1%, $R_L = 10 \text{ k}\Omega$ $f = 1 \text{ kHz}$	0.0	4.0	—	dBV	—
48	Maximum output level R-channel	VMALR5	1		0.0	4.0	—	dBV	—

■ Electrical Characteristics at $V_{CC} = 5.0\text{ V}$, $V_{CC-SP} = 5.0\text{ V}$ (continued)

 Note) $T_a = 25^\circ\text{C} \pm 2^\circ\text{C}$ unless otherwise specified.

B No.	Parameter	Symbol	Test circuits	Conditions	Limits			Unit	Note
					Min	Typ	Max		
Line amplifier part (continued) : L-channel, R-channel_input (pin 28, pin 27) → Headphone_output (pin 29, pin 30)									
49	Output noise L-channel	VNLL	1	$R_g = 1\text{ k}\Omega$, A curve filter	—	-105	-87	dBV	—
50	Output noise R-channel	VNLR	1		—	-105	-87	dBV	—
51	Cross talk in L-channel	CTLLLR	1	$V_{IN} = -10\text{ dBV}$, $R_L = 10\text{ k}\Omega$ $f = 10\text{ kHz}$, A curve filter	60	84	—	dB	—
52	Cross talk in R-channel	CTLLRL	1		60	84	—	dB	—
53	Mute attenuation quantity L-channel	VMUHL	1	$V_{IN} = -10\text{ dBV}$, $R_L = 10\text{ k}\Omega$ $f = 1\text{ kHz}$, A curve filter	70	87	—	dB	—
54	Mute attenuation quantity R-channel	VMUHR	1		70	87	—	dB	—
Speaker AGC part : Speaker_input (pin 44, pin 45) → Speaker_output (pin 2 to pin 5, pin 52 to pin 55)									
55	Speaker amplifier output level L-channel AGC-on1	VAGSPL	1	$V_{IN} = -3.0\text{ dBV}$, $f = 1\text{ kHz}$, $R_L = 8\ \Omega$	4.5	6.0	7.5	dBV	—
56	Speaker amplifier output level R-channel AGC-on1	VAGSPR	1		4.5	6.0	7.5	dBV	—
57	Speaker amplifier output level L-channel AGC-on2	VAGSP1L	1		5.5	7.0	8.5	dBV	—
58	Speaker amplifier output level R-channel AGC-on2	VAGSP1R	1		5.5	7.0	8.5	dBV	—
Automatic signal detection part : L-channel, R-channel_input (pin 28, pin 27) → Signal detection preamplifier output (pin 12)									
59	Preamplifier output voltage level L-channel entry	VSDTL	1	$V_{IN} = -33\text{ dBV}$, $f = 1\text{ kHz}$ $Vol = 1.65\text{ V (typ)}$	-13	-10	-7	dBV	—
60	Preamplifier output voltage level R-channel entry	VSDTR	1		-13	-10	-7	dBV	—
61	Signal detection limit entry voltage level L-channel	VSDTTHL	1	$V_{IN} = 1\text{ kHz}$ $Vol = 1.65\text{ V (typ)}$	-63	-58	-53	dBV	—
62	Signal detection limit entry voltage level R-channel	VSDTTHR	1		-63	-58	-53	dBV	—
Switch switching-over voltage level									
63	Headphone mute on	HMUON	1		GND	—	0.8	V	—
64	Headphone mute off	HMUOF	1		2.0	—	5.5	V	—
65	Headphone power save on	HPSON	1		GND	—	0.8	V	—
66	Headphone power save off	HPSOF	1		2.0	—	5.5	V	—
67	Speaker power save on	SPSON	1		GND	—	0.8	V	—
68	Speaker power save off	SPSOF	1		2.0	—	5.5	V	—
69	Standby on	STON	1		GND	—	0.8	V	—
70	Standby off	STOF	1		2.0	—	5.5	V	—
71	Line mute on	LMUON	1		GND	—	0.8	V	—
72	Line mute off	LMUOF	1		2.0	—	5.5	V	—

■ Electrical Characteristics at $V_{CC} = 5.0\text{ V}$, $V_{CC_SP} = 5.0\text{ V}$ (continued)

 Note) $T_a = 25^\circ\text{C} \pm 2^\circ\text{C}$ unless otherwise specified.

B No.	Parameter	Symbol	Test circuits	Conditions	Limits			Unit	Note
					Min	Typ	Max		
Switch switching-over voltage level (continued)									
73	Signal automatic detection feature off	ATOF	1		GND	—	0.8	V	—
74	Signal automatic detection feature on	ATON	1		2.0	—	5.5	V	—
75	Speaker-AGC off	AGOF	1		GND	—	0.5	V	—
76	Speaker-AGC on2	AGON1	1		—	Open	—	V	—
77	Speaker-AGC on1	AGON	1		2.5	—	5.5	V	—
78	Switch A Off	CMUOF	1		GND	—	0.8	V	—
79	Switch A On	CMUON	1		2.0	—	5.5	V	—
80	Switch B Off	DMUOF	1		GND	—	0.8	V	—
81	Switch B On	DMUON	1		2.0	—	5.5	V	—

■ Control Terminal, The Mode Table

Note) The holding range of control voltage is shown in B No. 63 to B No. 81 of ■ Electrical Characteristics.

Pin No.	Description	Voltage		Remarks
		Low	High	
37	Headphone mute on/off	Mute on	Mute off	—
36	Headphone power save on/off	Save on (HP off)	Save off (HP on)	—
49	The signal automatic detection feature on/off	Automatic distinction: off	Automatic distinction: on	—
32	Standby on/off	STB on	STB off	—
50	Speaker power save on/off	Save on (SP off)	Save off (SP on)	It has priority over power saving by pin 50 more than an automatic detection.
35	Switch A	Off	On	—
33	Switch B	Off	On	—
31	Line mute on/off	Mute on	Mute off	—

Pin No.	Description	Voltage		
		Low	Open	High
8	At the time of time of AGC: on, it changes on level.	AGC: off	AGC: on2	AGC: on1

■ Control Terminal, The Leakage Current Table at $V_{CC} = 5.0\text{ V}$, $V_{CC_SP} = 5.0\text{ V}$

- Design reference value

Pin No.	Description	Leakage current		Input impedance
		I_{iL-max}	I_{iH-max}	
33	Switch B	+2 μA	+80 μA	The low holding range: High impedance The high holding range: About 80 k Ω
35	Switch A	+2 μA	+80 μA	The low holding range: High impedance The high holding range: About 80 k Ω
37	Headphone mute on/off	-20 μA	+30 μA	About 170 k Ω
8	At the time of AGC = on, it changes on level.	-20 μA	+50 μA	About 125 k Ω

Pin No.	Description	In the case of less than the voltage of the input voltage limitation circuit			In the case beyond the voltage of the input voltage limitation circuit		
		Leakage current		Input impedance	Leakage current		Input impedance
		I_{iL-max}	I_{iH-max}		I_{iL-max}	I_{iH-max}	
31	Line mute on/off	+1 μA	+1 μA	High impedance	—	+100 μA	25 k Ω typ.
32	Standby on/off	+1 μA	+1 μA	High impedance	—	+50 μA	45 k Ω typ.
36	Headphone power save on/off	-1 μA	+1 μA	High impedance	+40 μA	+200 μA	16 k Ω typ.
49	Signal automatic detection feature on/off	+1 μA	+1 μA	High impedance	—	+20 μA	85 k Ω typ.
50	Speaker power save on/off	-1 μA	+1 μA	High impedance	+5 μA	+200 μA	15 k Ω typ.



- The sourcing current of the pin is indicated with “+”.
- The range that a control voltage is held in low level :
Pin 33, pin 35, pin 37, pin 31, pin 32, pin 36, pin 49, pin 50 : 0 V ~ 0.8 V
Pin 8 : 0 V ~ 0.5 V
- The range that a control voltage is held in high level :
Pin 33, pin 35, pin 37, pin 31, pin 32, pin 36, pin 49, pin 50 : 2.0 V ~ 5.5 V
Pin 8 : 2.5 V ~ 5.5 V
- Pin 31, pin 32, pin 36, pin 49 and pin 50 builds in an input voltage limitation circuit.
- In the case beyond the voltage of the input voltage limitation circuit, leakage current depends on inside resistance.
- When resistance is connected to a pin, current decreases by the sum total of resistance and internal resistance.

Note) The characteristics listed above are reference values based on the IC design and are not guaranteed.

■ Technical Data

- Circuit diagrams of the input/output part and pin function descriptions

Note) The characteristics listed below are reference values based on the IC design and are not guaranteed.

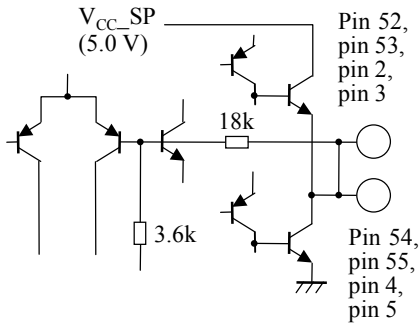
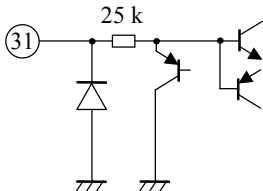
Pin No.	Waveform and voltage	Inner circuit	Impedance	Description
1, 56	V _{CC_SP} DC: 5.0 V	—	—	Power supply pins specifically designed for speaker amplifiers. <ul style="list-style-type: none"> • Pin 1 for R-channel. • Pin 56 for L-channel. Because the big electric current flows, it is desirable to separate from the V _{CC} line to the other power supply pins on the board pattern.
52, 53, 54, 55, 2, 3, 4, 5	Speaker output Pin 52, pin 53 Pin 2, pin 3 Positive phase  Pin 54, pin 55 Pin 4, pin 5 Negative phase  DC: 2.20 V AC: 4 dBV		The output impedance: Equal to or less than 1 Ω	Output pins of speaker amplifiers. It becomes BTL output. <ul style="list-style-type: none"> • Pin 54, pin 55 for L-channel positive phase output • Pin 52, pin 53 for L-channel negative phase output • Pin 2, pin 3 for R-channel positive phase output • Pin 4, pin 5 for R-channel negative phase output To reduce voltage loss caused by the wire resistance in maximum output, it makes output 2 terminals. When the speaker amplifiers save power, DC voltage is also kept.
51, 6	GND_SP DC : 0.0 V	—	—	It is GND pin for the speaker amplifier. <ul style="list-style-type: none"> • Pin 6 is for R-channel. • Pin 51 is for L-channel. Because the big electric current flows, it is desirable to separate from the GND line to the other GND pin on the board pattern. Also, it isn't connected with the substrate potential in the IC.
31	Line mute control		The base entry (With the resistance) In the range which entry limiter does not depend on, it is high impedance.	It controls on/off of the mute function of the line output.

■ Technical Data (continued)

- Circuit diagrams of the input/output part and pin function descriptions (continued)



Note) The characteristics listed below are reference values based on the IC design and are not guaranteed.

Pin No.	Waveform and voltage	Inner circuit	Impedance	Description
7	<p>Audio automatic detection detection pin:</p> <p>Signal nothing DC: 0.0 V</p> <p>Signal's there being DC: 2.0 V</p>		<p>Signal less time: Constant current source</p> <p>Signal's there being: The output impedance: About 200 Ω</p>	<p>It connects a condenser for the peak detection. It is the circuit which detects a peak after rectifying the audio signal automatic detection circuit in both waves. By changing a capacity value, the time which the power saving depends on in case of the switchover which is without signal with signal's there being can be changed.</p>
9, 15, 26, 38, 42, 48	<p>GND</p> <p>DC: 0.0 V</p>		—	<p>It is the GND pins of the signal system. It is connected with the substrate potential of the IC. Pin 15, pin 42 connect with the lead frame of the IC.</p>
43	<p>V_{REF} (SP)</p> <p>DC: 2.20 V</p>		<p>The entry impedance: About 200 kΩ</p>	<p>It is the standard voltage pin to fix the DC bias of the speaker output. It connects a condenser to remove a ripple.</p>
29, 30	<p>Line out</p> <p>AC: -9.17 dBV</p> <p>DC : 2.25 V</p>		<p>The output impedance: Equal to or less than about 10 Ω</p>	<p>It is the output pin of the line amplifier.</p>

■ Technical Data (continued)

- Circuit diagrams of the input/output part and pin function descriptions (continued)

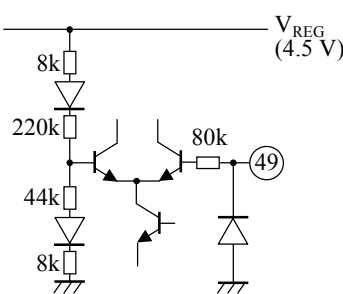
Note) The characteristics listed below are reference values based on the IC design and are not guaranteed.

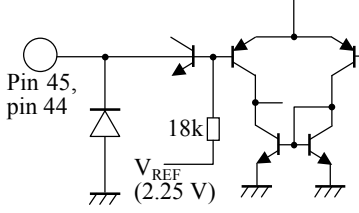
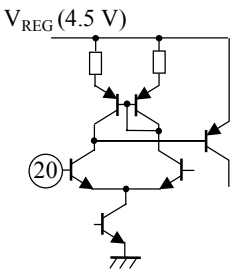
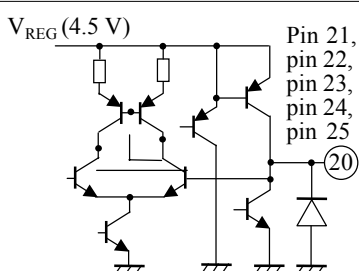
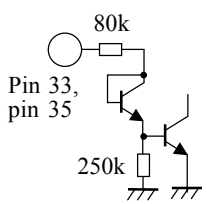
Pin No.	Waveform and voltage	Inner circuit	Impedance	Description
49	Signal automatic detection function on/off control pin DC: —		The entry impedance: The high impedance	We change an audio signal automatic detection function in on/off. In case of automatic detection off, it controls power saving by speaker with the manual with the power saving on/off pin. • High: Function on • Low: Function off
44, 45	Speaker amplifier entry  DC: 2.25 V AC: -10 dBV		The entry impedance: About 18 kΩ	It is the voice input pins of the speaker amplifier. To make offset voltage in power saving on/off changing by the speaker amplifier little, it combines capacity. (It makes POP noise small). Pin 44: R-channel speaker entry Pin 45: L-channel speaker entry
20	BV _{REF} DC: — V		The entry impedance: The high impedance	It is the input pin of BV _{REF} .
21, 22, 23, 24, 25	Switch A-1 Switch A-2 Switch A-3 Switch B-1 Switch B-2 DC: — V		The output impedance: Equal to or less than about 10 Ω	It is the output pin of BV _{REF} .
33, 35	Switch B Switch A DC: 0 V (at Open)		The entry impedance: About 80 kΩ	We change a noise removal function in on/off. • High: Function on • Low: Function off

■ Technical Data (continued)

- Circuit diagrams of the input/output part and pin function descriptions (continued)



Note) The characteristics listed below are reference values based on the IC design and are not guaranteed.

Pin No.	Waveform and voltage	Inner circuit	Impedance	Description
17	<p>Pri_charge level pin</p> <p>DC: 3 V</p>		<p>The entry impedance: About 100 kΩ</p>	<p>It is the voltage pin for DC bias pri_charge.</p>
27, 28	<p>Audio signal input</p> <p>DC: 2.25 V AC: -10 dBV</p>		<p>The entry impedance: About 22.5 kΩ</p>	<p>It enters a main audio signal.</p> <ul style="list-style-type: none"> • Pin 27: R-channel entry • Pin 28: L-channel entry
16, 41	<p>V_{CC}</p> <p>DC: 5.0 V</p>	<p>—</p>	<p>—</p>	<p>It is the power supply (V_{CC}) pin to supply the regulator circuit to create the inner power supply V_{REG} with the voltage. It is separating from V_{CC_SP} of pin 1, pin 56 fully inside. It is desirable to separate as far as it finishes coming out about the P board pattern, too.</p>
32	<p>Standby on/off changing SW</p> <p>Open DC voltage DC: 0.00 V</p>		<p>The entry impedance: About 80 kΩ</p>	<p>It changes whether or not it makes this IC an operation condition or whether or not it makes it a standby.</p> <ul style="list-style-type: none"> • Low: Standby • High: The operation condition <p>In that the power changes a connected condition to the standby, the circuit electric current can be almost made 0.</p>

■ Technical Data (continued)

- Circuit diagrams of the input/output part and pin function descriptions (continued)

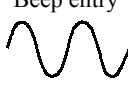
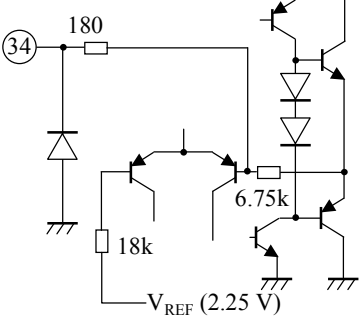
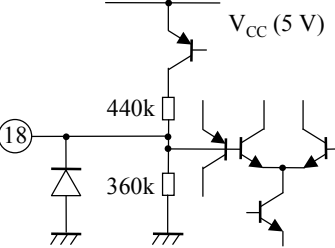
Note) The characteristics listed below are reference values based on the IC design and are not guaranteed.

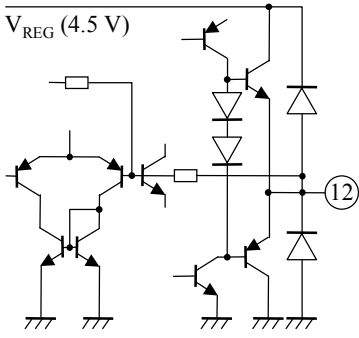
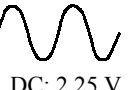
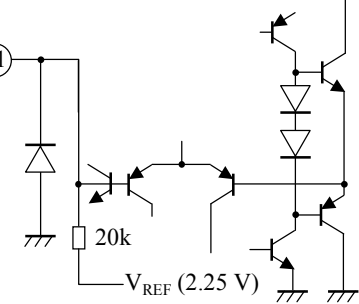
Pin No.	Waveform and voltage	Inner circuit	Impedance	Description
34	<p>Beep entry</p>  <p>DC: 2.25 V AC: 3.3 V_{PP}</p>		<p>The entry impedance: About 180 kΩ</p>	<p>It is the entry pin to enter beep signal. The same signal is entered both by L-channel and R-channel with the audio signal mix amplifier of the following paragraph.</p>
18	<p>V_{REF}</p> <p>DC: 2.25 V</p>		<p>The entry impedance: About 200 kΩ</p>	<p>With the pin to fix the bias voltage (the operation point) of the system which the inner power supply (V_{REG}) works, it becomes 1/2 V_{REG} (V). To remove noise, it connects a condenser with the interval of GND.</p>
12	<p>The signal detection system preamplifier output pin</p>  <p>DC: 2.25 V AC: -10 dBV</p>		<p>The output impedance: About 10 Ω</p>	<p>It is the output pin of the signal detection system preamplifier.</p>
11	<p>Signal input for signal automatic detection</p>  <p>DC: 2.25 V AC: -10 dBV</p>		<p>The entry impedance: About 20 kΩ</p>	<p>It is the signal input pin for signal automatic detection. It is possible to adjust in the direction lowers a gain by adding external resistance.</p>

■ Technical Data (continued)

- Circuit diagrams of the input/output part and pin function descriptions (continued)

Note) The characteristics listed below are reference values based on the IC design and are not guaranteed.

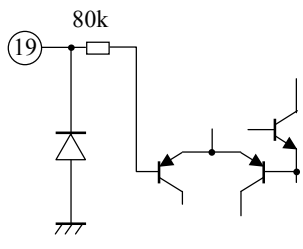
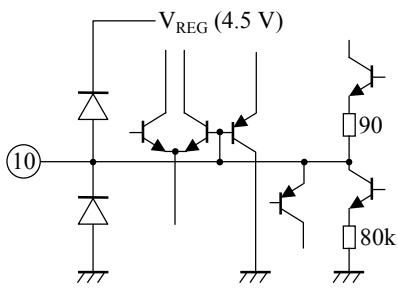
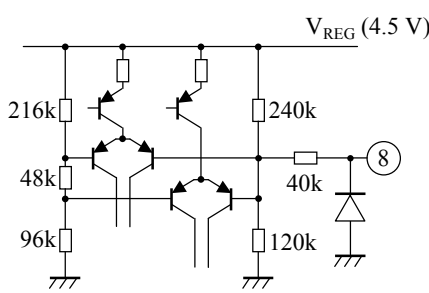
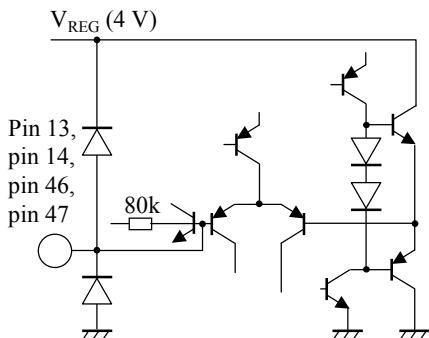
Pin No.	Waveform and voltage	Inner circuit	Impedance	Description
19	EVR control for SP and HP DC: — V		The entry impedance: The high impedance	It is the pin which controls EVR for speaker amplifier and Headphone amplifier. The holding range with control voltage is 0 V to 3.3 V.
10	AGC detection pin DC: 0 V ~ 1 V		The entry impedance: Unsettled	It is the detection circuit to detect the signal level of the AGC circuit of the speaker output for the clip prevention. It connects a condenser for the detection.
8	AGC on1/on2/off control pin DC: —		The entry impedance: About 76 kΩ	It is the pin which controls the operation of the AGC circuit of the speaker output for the clip prevention in on/off. At the time of off, the AGC circuit does not work. • "High" : AGC-on1 • "Open" : AGC-on2 • "Low" : AGC-off
13, 14, 46, 47	Offset cancellation C pin DC : 2.25 V		The entry impedance: About 80 kΩ	It is the condenser connection pin of the offset cancellation circuit to remove the DC offset. As the principle, it composes high pass filter by entry impedance "R" and connection condenser "C".

■ Technical Data (continued)

- Circuit diagrams of the input/output part and pin function descriptions (continued)

Note) The characteristics listed below are reference values based on the IC design and are not guaranteed.

Pin No.	Waveform and voltage	Inner circuit	Impedance	Description
50	SP amplifier power saving on/off control pin DC: —		The entry impedance: The high impedance	It is the pin which controls power saving by the speaker amplifier. At the time of on in addition to the control in case of automatic distinction function off, too, power saving on by pin 50 have priority over.
36	HP amplifier power saving on/off control pin DC: —		The entry impedance: The high impedance	It is the pin which controls power saving by the headphone amplifier.
37	HP amplifier mute on/off control terminal DC : 2.0 V		The input impedance: Equal to or less than about 170 kΩ	It controls on/off of the mute function of the headphone output.
39, 40	Output terminal for the HP amplifier DC : 2.20 V AC : -4 dBV		The output impedance: Equal to or less than about 1 Ω	It is an output pin for the headphone amplifier. The signal which was adjusted in the volume in EVR can be output by the low impedance.

■ Technical Data (continued)

- Power dissipation of package HSOP056-P-0300A

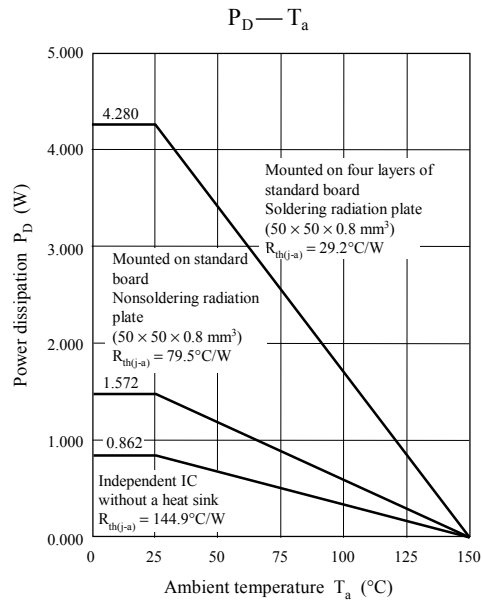

Note) The characteristics listed above are reference values based on the IC design and are not guaranteed.

■ Technical Data (continued)

• Main characteristics

1) Speaker amplifier

Speaker I/O characteristics – 8 Ω

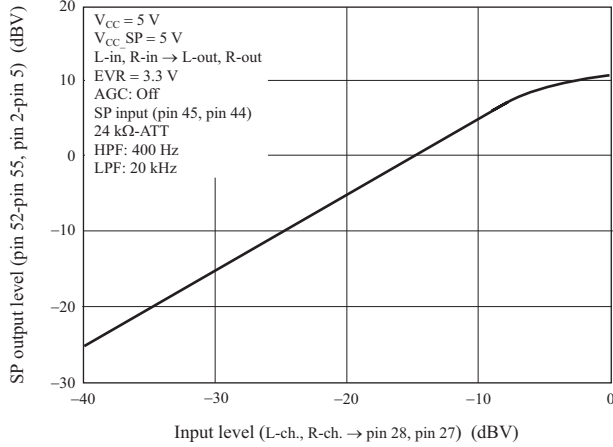

Speaker I/O characteristics – 8 Ω

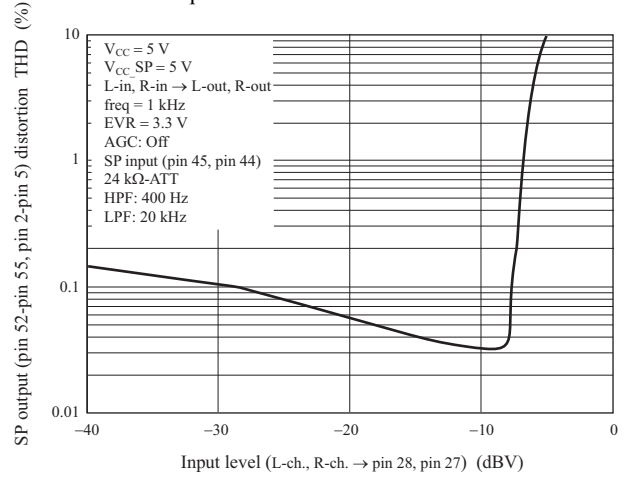

Speaker output frequency characteristics – 8 Ω

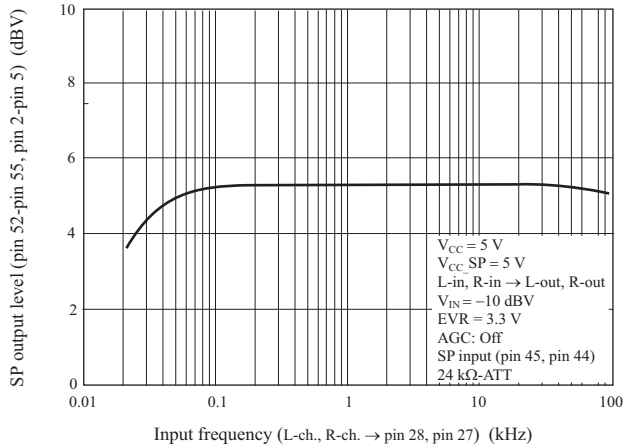

Speaker output frequency characteristics – 8 Ω

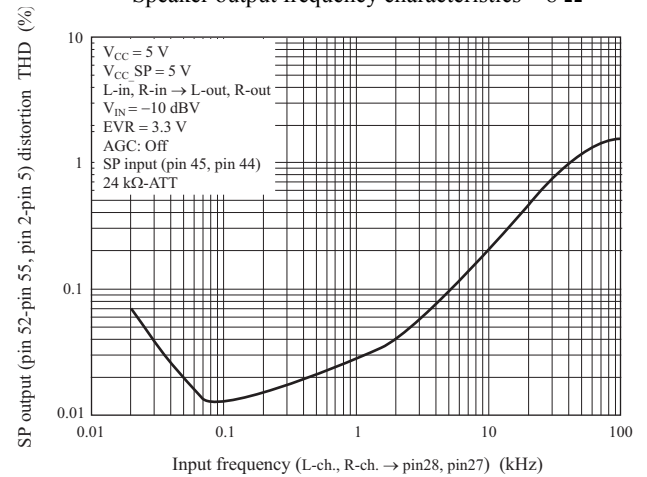

Speaker output frequency characteristics – 8 Ω

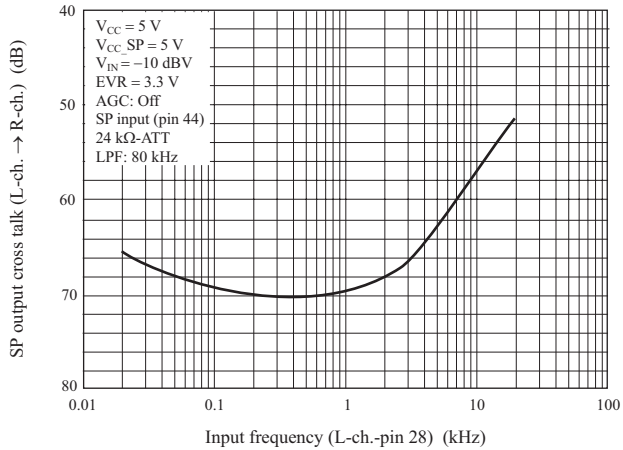

Speaker output frequency characteristics – 8 Ω

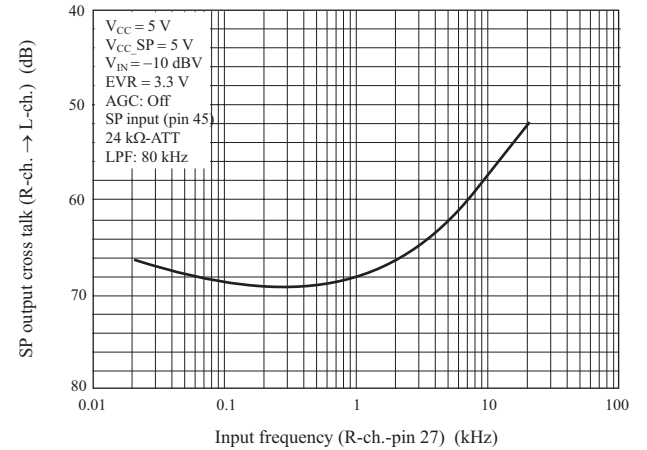

■ Technical Data (continued)

- Main characteristics

2) Headphone amplifier

Headphone amplifier I/O characteristics - EVR = max

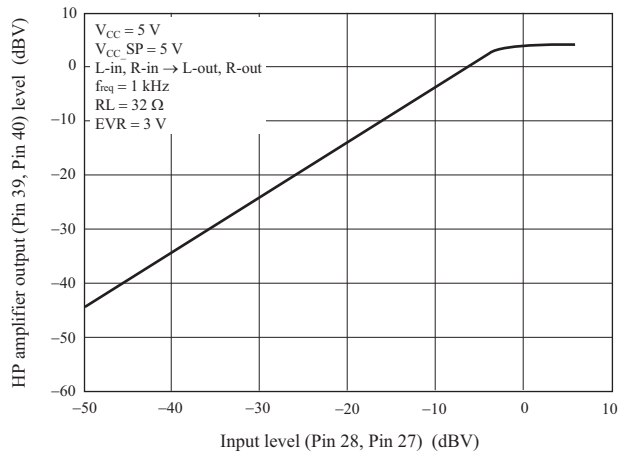

Headphone amplifier I/O distortion characteristics - EVR = max

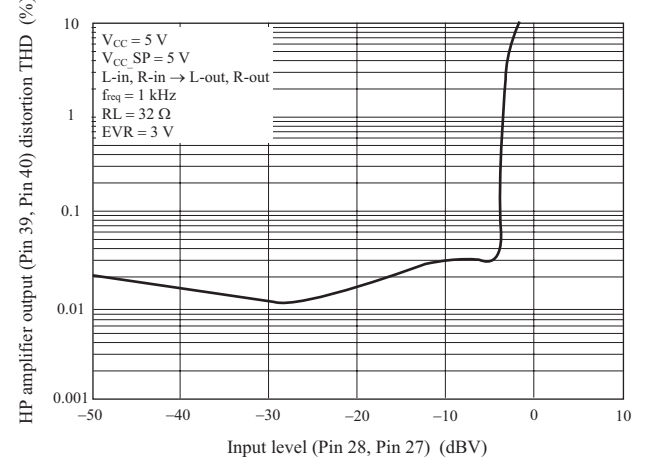

Headphone amplifier frequency characteristics - EVR = max

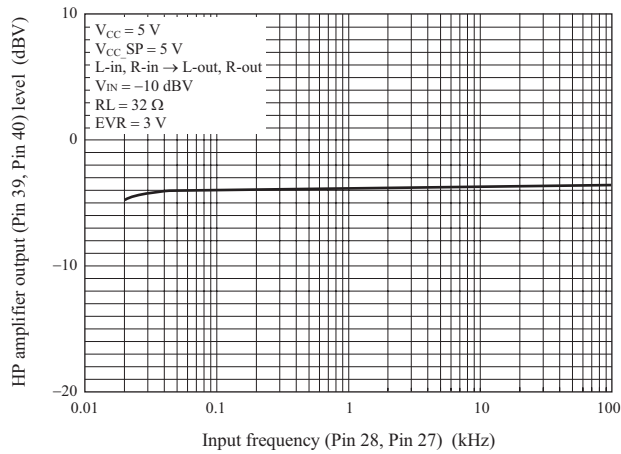

Headphone amplifier frequency characteristics - EVR = max

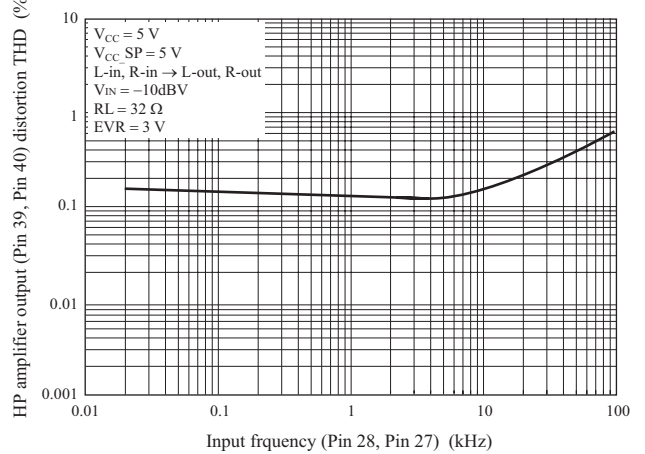

■ Technical Data (continued)

- Main characteristics (continued)

2) Headphone amplifier (continued)

Headphone amplifier I/O characteristics - EVR = typ

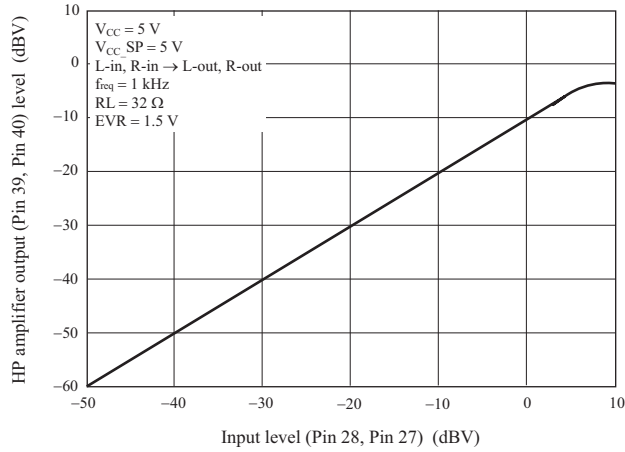

Headphone amplifier I/O distortion characteristics - EVR = typ

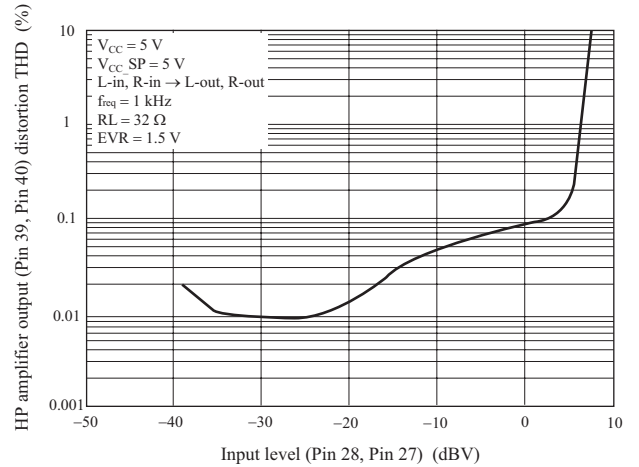

EVR attenuate level characteristics – Headphone output

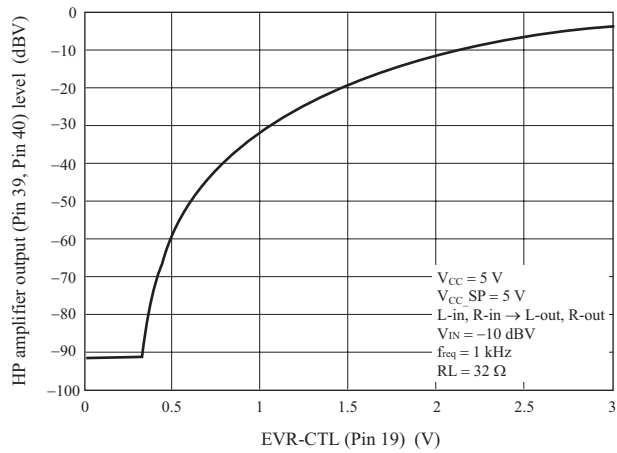

EVR attenuate distortion characteristics – Headphone output

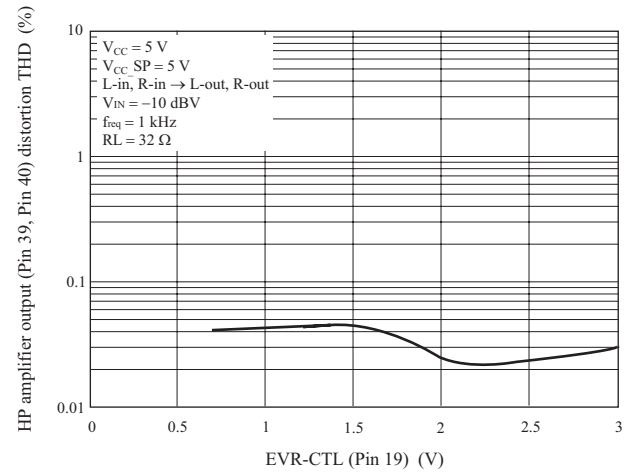

■ Application Notes

1. Linear amplifier circuit block

Following block diagrams is line amplifier circuit.

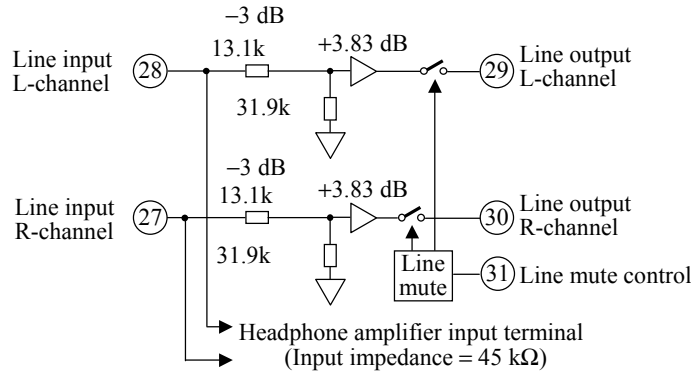

- 1) The gain of the linear amplifier system is +0.83 dB.
- 2) To become a connection of the standing in the row, the entry impedance of pin 28, pin 27 becomes 22.5 kΩ.
It stores up that these pins also serve as the headphone entry (the impedance = 45 kΩ).
- 3) It is possible to adjust to the direction which lowers a gain in adding resistance to pin 28, pin 27.
But, the gain of the headphone system, too, changes at the same time.

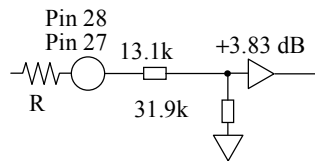

If external resistance is “R”

$$\text{Gain} = 20 \log \frac{31.9 \text{ k}\Omega}{R + 13.1 \text{ k}\Omega + 31.9 \text{ k}\Omega}$$

- 4) By the mute control by pin 31, the line can be output in the mute.
- 5) For the pop sound measure at the time of power on, delay from the standby cancellation by pin 32 and cancel a linear mute.
(Refer to sheet no.2 for circuit constant.)

■ Design reference value

Parameter	Design reference value	Note
The input/output gain	+0.83 dB	
Input impedance	22.5 kΩ	Note) *: It done the change being of ±10% because there is a change of the inner resistance.
Output impedance	Equal to or less than 10 Ω	Note) *: But, it limits into the sound band range of equal to or less than 50 kHz.
Maximum input level	1.6 dBV	Note) *: The time of the warp (to 5th of THD) of 1% of output.
Maximum output level	3.0 dBV	Note) *: The time of the warp (to 5th of THD) of 1% of output.
Ability of the output drive	Equal to or more than 10 kΩ of loads	

■ Application Notes (continued)

2. Headphone amplifier circuit block

Following block diagrams is headphone amplifier circuit.

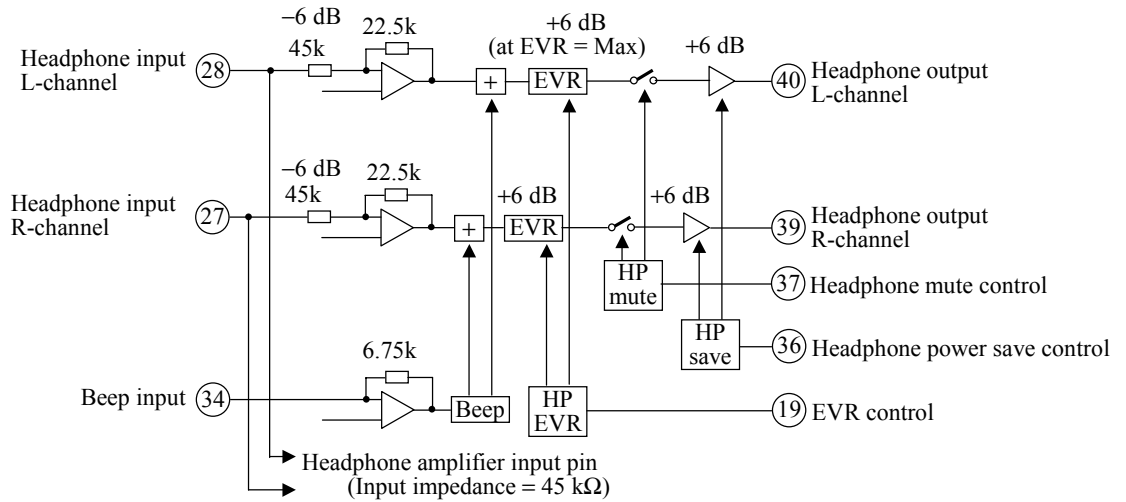

- 1) The gain of the headphone amplifier system is +6.0 dB when EVR is maximum.
- 2) To become a connection of the standing in the row, the entry impedance of pin 28, pin 27 becomes 22.5 kΩ.
It stores up that these pin also serve as the headphone entry (the impedance = 45 kΩ).
- 3) It is possible to adjust to the direction which lowers a gain in adding resistance to pin 28, pin 27.
But, the gain of the line system, too, changes at the same time.

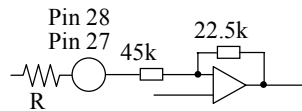

If external resistance is "R"

$$\text{Gain} = 20 \log \frac{22.5 \text{ k}\Omega}{R + 45 \text{ k}\Omega}$$

- 4) By the mute control by pin 37, the headphone can be output in the mute.
- 5) By the EVR control of pin 19, the gain of the headphone output can be variably done.
- 6) The entry of the beep circuit of pin 34 is a virtual grounding entry. Therefore, the external resistance is necessary.
- 7) For the pop sound measure at the time of power on, delay from the standby cancellation by pin 32 and cancel a headphone save mute.

(Refer to sheet no.2 for circuit constant.)

- 8) When high impedance load is likely to be connected to headphone amplifier output, insert a resistor of 1 Ω to 4.7 kΩ so as to lower shock noise at power on or standby on/off.

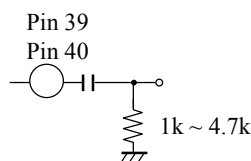

■ Application Notes (continued)

2. Headphone amplifier circuit block (continued)

- Beep signal I/O

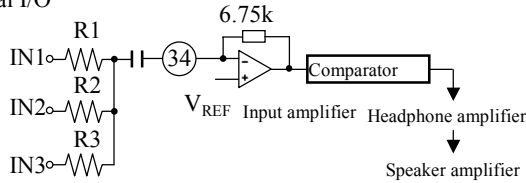

Since input amplifier is of a reverse amplifier system, any input to pin 34 through a resistor from some circuits would not cause any drop of input impedance.

Gain of in 1

$$\text{Gain} = 20 \log \frac{6.75 \text{ k}\Omega}{R1}$$

Gain of in 2

$$\text{Gain} = 20 \log \frac{6.75 \text{ k}\Omega}{R2}$$

Threshold level of comparator is 0.1 Vrms to 0.4 Vrms.

Therefore, keep output of input amplifier equal to or more than 0.4 Vrms.

Equal to or more than 0.4 Vrms ensures that a certain level of beep sound is output to the speaker.

Beep I/O level characteristics : Speaker load - 8 Ω

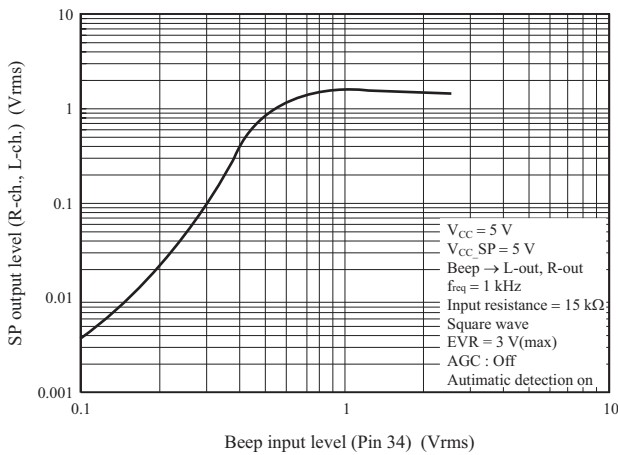

Beep frequency level characteristics : Speaker load - 8 Ω

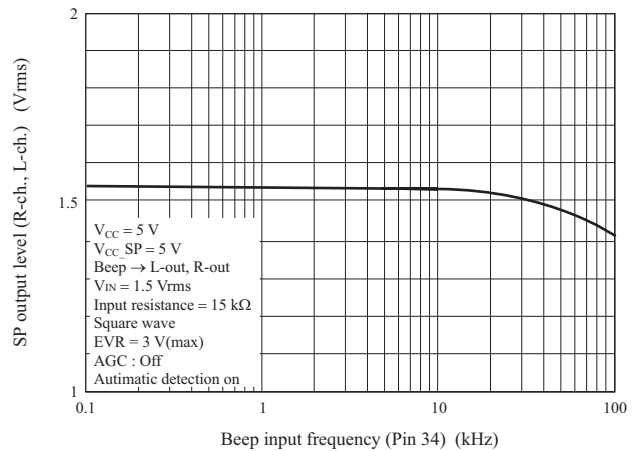

■ Design reference value

Parameter	Design reference value	Note
The input/output gain	+6.0 dB	Note) *: At EVR is maximum.
Input impedance	22.5 kΩ	Note) *: It done the change being of ±10% because there is a change of the inner resistance.
Output impedance	Equal to or less than 1 Ω	Note) *: But, it limits into the sound band range of equal to or less than 50 kHz.
Maximum input level	3.0 dBV	Note) *: The time of the warp (to 5th of THD) of 1% of output.
Maximum output level	2.4 dBV	Note) *: The time of the warp (to 5th of THD) of 1% of output.
Ability of the output drive	Equal to or more than 32 Ω of loads	

■ Application Notes (continued)

3. Speaker amplifier circuit block

Following block diagrams is speaker amplifier circuit.

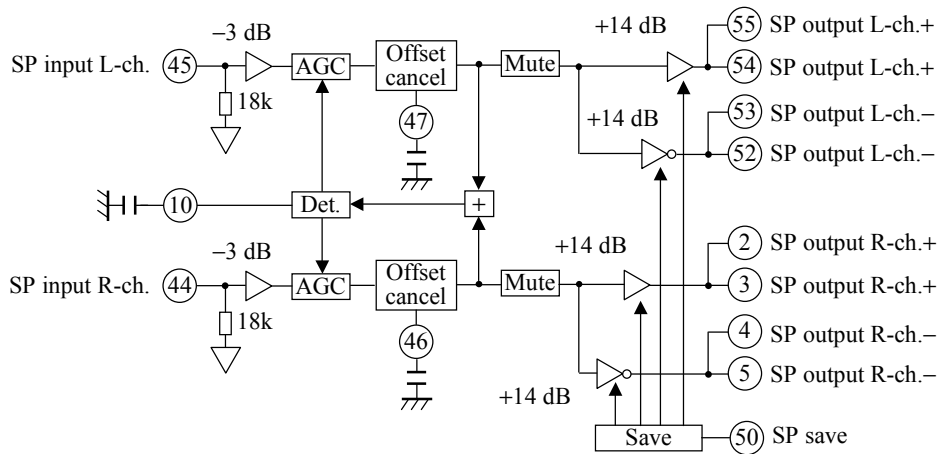

- 1) The gain of the speaker amplifier system is +17.0 dB.
- 2) The entry impedance of pin 45, pin 44 becomes 18 kΩ.
- 3) It is possible to adjust to the direction which lowers a gain in adding resistance to pin 28, pin 27.

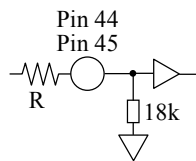

Gain at insert a resistance

$$\text{Gain} = 20 \log \frac{18 \text{ k}\Omega}{R + 18 \text{ k}\Omega} + 17 \text{ dB}$$

- 4) By the power save control by pin 50, the speaker can be output in the save mute.
- 5) For the pop sound measure at the time of power on, delay from the standby cancellation by pin 32 and cancel a speaker save mute.

■ Design reference value

Parameter	Design reference value	Note
The input/output gain	+17.0 dB	
Input impedance	18 kΩ	Note) *: It done the change being of ±10% because there is a change of the inner resistance.
Output impedance	Equal to or less than 1 Ω	Note) *: But, it limits into the sound band range of equal to or less than 50 kHz.
Maximum output level	1 W : at 8 Ω of loads	Note) *: The time of the warp (to 5th of THD) of 10% of output.
Ability of the output drive	Equal to or more than 8 Ω of loads	

■ Application Notes (continued)

- The output wave at the time of AGC operation

It is the following output wave form chart at the AGC operation time.

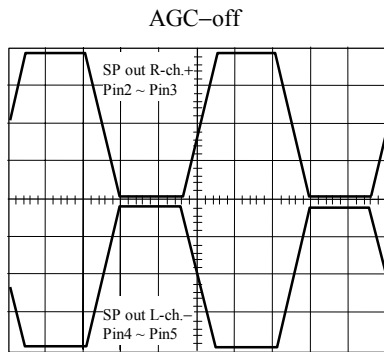

- $V_{CC} = 5\text{ V}$
- $V_{CC_SP} = 5\text{ V}$
- $V_{IN} = 1\text{ Vrms}$
- $f = 1\text{ kHz}$
- SP R-ch. input (Pin 44)
- SP out R-ch. load $8\ \Omega$
- Output : 1.34 W

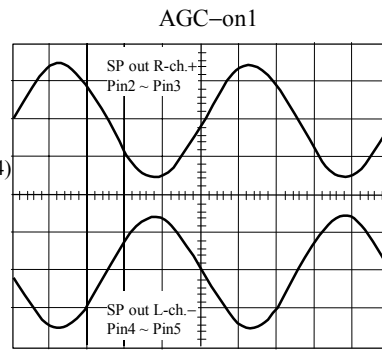

- $V_{CC} = 5\text{ V}$
- $V_{CC_SP} = 5\text{ V}$
- $V_{IN} = 1\text{ Vrms}$
- $f = 1\text{ kHz}$
- SP R-ch. input (Pin 44)
- SP out R-ch. load $8\ \Omega$
- Output : 0.54 W

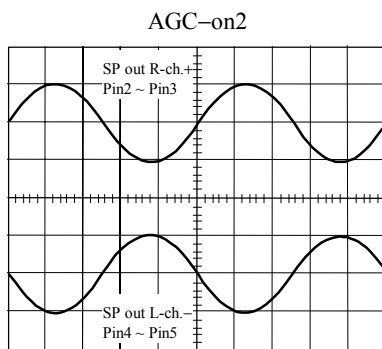

- $V_{CC} = 5\text{ V}$
- $V_{CC_SP} = 5\text{ V}$
- $V_{IN} = 1\text{ Vrms}$
- $f = 1\text{ kHz}$
- SP R-ch. input (Pin 44)
- SP out R-ch. load $8\ \Omega$
- Output : 0.28 W

Example: Output waveform of sound signal input

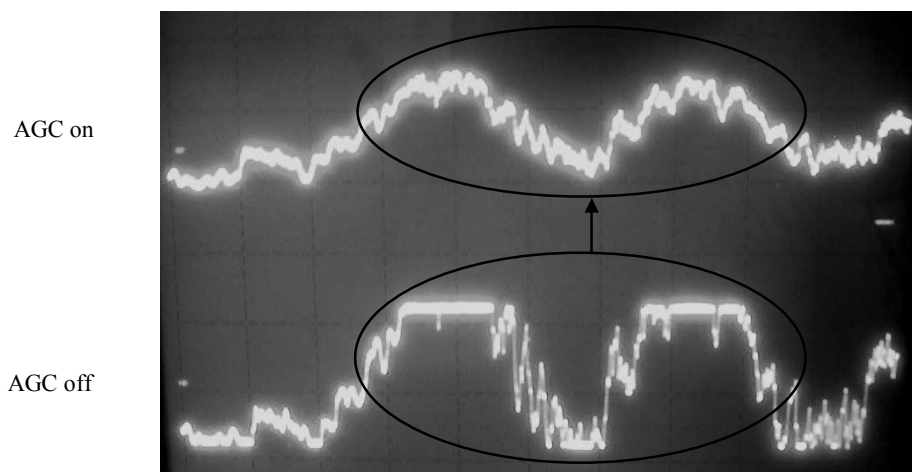

■ Application Notes (continued)

4. Automatic power save of speaker amplifier function

When input signal becomes zero or very small, a speaker amplifier is automatically power save off.

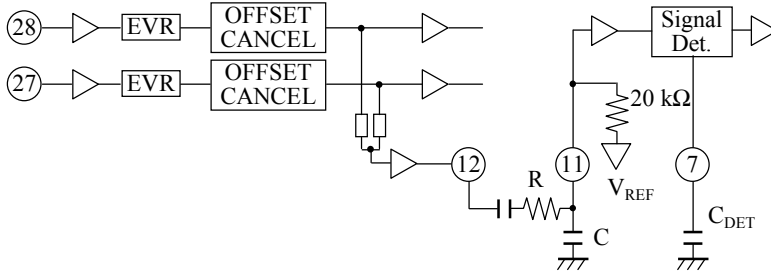

In the case that a detection circuit operation error to noise, insert “R” and “C” between pin 12 and pin 11 to prevent operation error.

$$f_c = \frac{1}{2\pi RC}$$

However, that insertion of “R” causes input signal to attenuate.

$$\text{Gain} = 20 \log \frac{20 \text{ k}\Omega}{R + 20 \text{ k}\Omega}$$

Setting L-channel, R-channel input of -58 dBV (Vol = 1.65 V) as detection threshold, insertion of “R” would drive detection threshold value up for the above gain..

C_{DET} of pin 7 is capacitor to determine detection time.

Det.capacity vs detection time
(Signal input → Speaker automatic power save off)

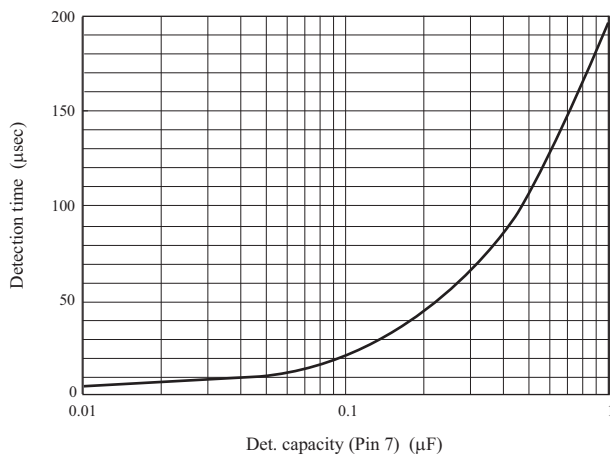

- Automatic off
(Detection time until audio output)
Measurement conditions
- V_{CC}, V_{CC-SP} = 5 V
 - Signal input → Time difference until speaker output
 - Measure time difference from signal input (sine wave) at no signal status until speaker output.
 - Speaker output (load 8 Ω) = -4 dBV, f = 1 kHz

Det.capacity vs detection time
(Input signal off → Speaker automatic power save on)

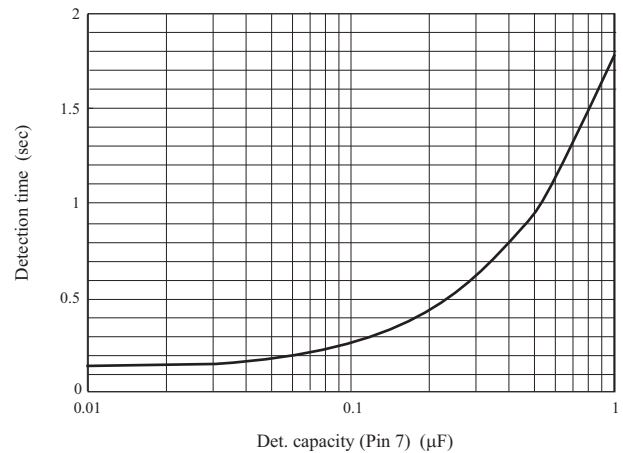

- Automatic power save on
(No sound → Time until power save)
Measurement conditions
- V_{CC}, V_{CC-SP} = 5 V
 - Input signal off → Time difference until speaker power save
 - Measure time difference from switching speaker signal (sine wave) output to no input until speaker power save.
 - Speaker output (load 8 Ω) = -4 dBV, f = 1 kHz

■ Application Notes (continued)
 5. Mute switch of signal line circuit

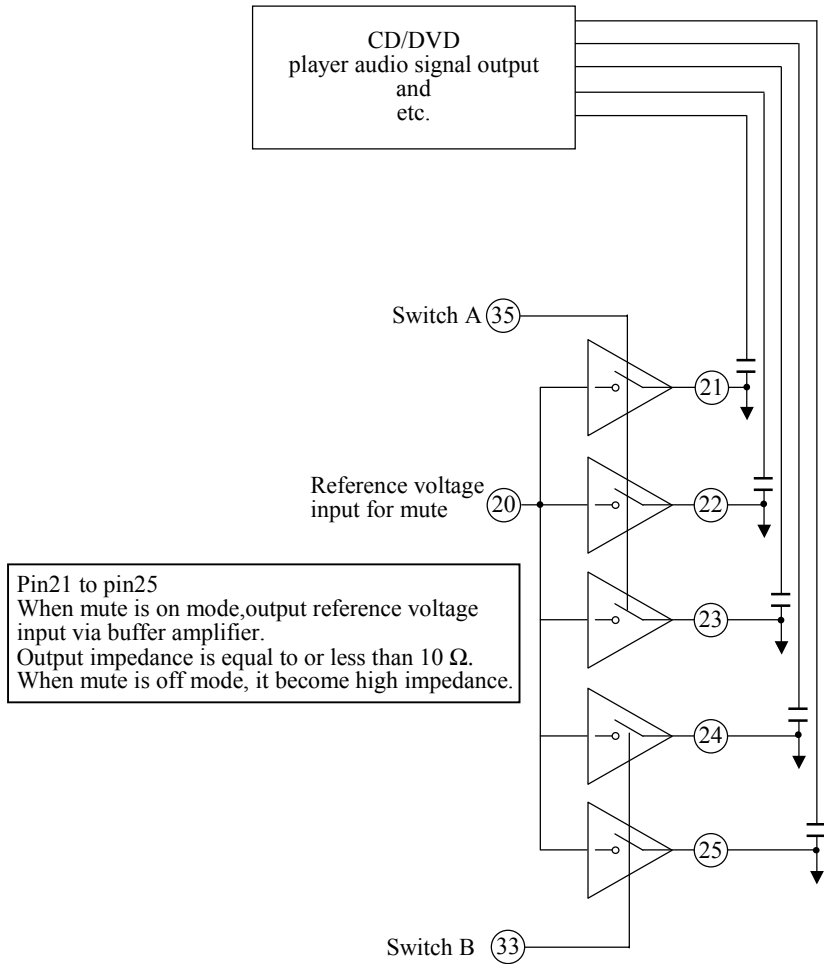

Note) * : Refer to sheet no.12 for circuit of inner IC

- Outside figure (Unit: mm)
- HSOP056-P-0300A (Lead-free package)

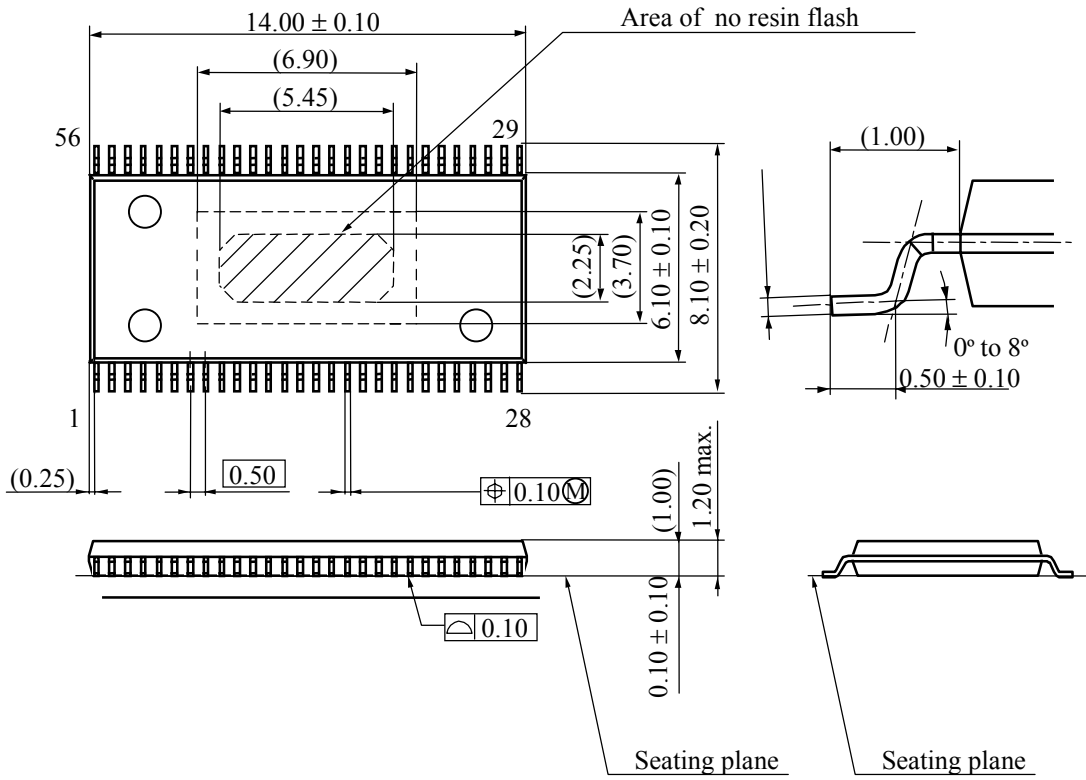

■ Usage Notes

- Avoid the power line short and the ground short of the terminals.
- Especially positive phase speaker output pins (pin 2, pin 3, pin 54 and pin 55) and negative phase speaker output pins (pin 4, pin 5, pin 52 and pin 53) have the possibility of break-down caused by the power line short and the ground short.
Be sure to avoid power line short, ground short and load short.

Request for your special attention and precautions in using the technical information and semiconductors described in this material

- (1) An export permit needs to be obtained from the competent authorities of the Japanese Government if any of the products or technologies described in this material and controlled under the "Foreign Exchange and Foreign Trade Law" is to be exported or taken out of Japan.
- (2) The technical information described in this material is limited to showing representative characteristics and applied circuits examples of the products. It neither warrants non-infringement of intellectual property right or any other rights owned by our company or a third party, nor grants any license.
- (3) We are not liable for the infringement of rights owned by a third party arising out of the use of the product or technologies as described in this material.
- (4) The products described in this material are intended to be used for standard applications or general electronic equipment (such as office equipment, communications equipment, measuring instruments and household appliances).
Consult our sales staff in advance for information on the following applications:
 - Special applications (such as for airplanes, aerospace, automobiles, traffic control equipment, combustion equipment, life support systems and safety devices) in which exceptional quality and reliability are required, or if the failure or malfunction of the products may directly jeopardize life or harm the human body.
 - Any applications other than the standard applications intended.
- (5) The products and product specifications described in this material are subject to change without notice for modification and/or improvement. At the final stage of your design, purchasing, or use of the products, therefore, ask for the most up-to-date Product Standards in advance to make sure that the latest specifications satisfy your requirements.
- (6) When designing your equipment, comply with the guaranteed values, in particular those of maximum rating, the range of operating power supply voltage, and heat radiation characteristics. Otherwise, we will not be liable for any defect which may arise later in your equipment.
Even when the products are used within the guaranteed values, take into the consideration of incidence of break down and failure mode, possible to occur to semiconductor products. Measures on the systems such as redundant design, arresting the spread of fire or preventing glitch are recommended in order to prevent physical injury, fire, social damages, for example, by using the products.
- (7) When using products for which damp-proof packing is required, observe the conditions (including shelf life and amount of time let standing of unsealed items) agreed upon when specification sheets are individually exchanged.
- (8) This material may be not reprinted or reproduced whether wholly or partially, without the prior written permission of Matsushita Electric Industrial Co., Ltd.