



**Absolute Maximum Ratings (Ta=25°C)**

Absolute maximum ratings indicate sustained limits beyond which damage to the device may occur. All voltage parameters are absolute voltages referenced to terminals stated, all currents are defined positive into any lead. The thermal resistance and power dissipation ratings are measured under board mounted and still air conditions.

Symbol	Definition	Terminal s	Max. Ratings	Units	Note
IDpeak	Drain Current * 1	1 - 3	15	A	Single Pulse
IDMAX	Maximum switching current *2	1 - 3	15	A	Ta=-20~+125°C
EAS	Single pulse avalanche energy *3	1 - 3	400	mJ	Single Pulse
					VDD=99V,L=20mH
					ILpeak =6.05A
Vcc	Input voltage for control part	4 - 3	35	V	
VSSOLP	SS/OLP pin voltage	5 - 3	-0.5 ~ 6.0	V	
IFB	FB pin inflow current	6- 3	10	mA	
VFB	FB pin voltage	6- 3	-0.5 ~ 9.0	V	within the limits of IFB
VOCPCB	O.C.P/F.B pin voltage	7- 3	-1.5 ~ 5.0	V	
PD1	Power dissipation of MOSFET *4	1 - 3	29	W	With infinite heatsink
			1.3		Without heatsink
PD2	Power dissipation for control part (MIC)	4 - 3	0.8	W	Specified by Vcc x Icc
TF	Internal frame temperature in operation	-	-20 ~ +115	°C	Refer to recommended operating temperature
Top	Operating ambient temperature	-	-20 ~ +115	°C	
Tstg	Storage temperature	-	-40 ~ +125	°C	
Tch	Channel temperature	-	150	°C	

\*1 Refer to MOS FET A.S.O. curve

\*2 Maximum switching current

The maximum switching current is the Drain current determined by the drive voltage of the IC and threshold voltage (Vth) of the MOS FET.

\*3 Refer to MOS FET Tch-EAS curve

\*4 Refer to MOS FET Ta-PD1 curve

**Electrical Characteristics (for Control IC)**

Electrical characteristics for control part (Ta=25°C, Vin=20V, unless otherwise specified)

Symbol	Definition	Terminal s	Ratings			Units	Note
			MIN	TYP	MAX		
<b>Power Supply Start-up Operation</b>							
$V_{CC(ON)}$	Operation Start Voltage	4 - 3	16.3	18.2	19.9	V	V <sub>CC</sub> =0→19.9V
$V_{CC(OFF)}$	Operation Stop Voltage	4 - 3	8.8	9.7	10.6	V	V <sub>CC</sub> =19.9→8.8 V
$I_{CC(ON)}$	Circuit Current in Operation	4 - 3	-	-	6	mA	-
$I_{CC(OFF)}$	Circuit Current in Non-Operation	4 - 3	-	-	100	μA	V <sub>CC</sub> =15V
f <sub>osc</sub>	Oscillation Frequency	1 - 3	19	22	25	kHz	-
$V_{SSOLP(SS)}$	Soft Start Operation Stop Voltage	5 - 3	1.1	1.2	1.4	V	-
$I_{SSOLP(SS)}$	Soft Start Operation Charging Current	5 - 3	-710	-550	-390	μA	-

<b>Normal Operation</b>							
$V_{OCPBD(BS1)}$	Bottom-Skip Operation Threshold Voltage1	7 - 3	-0.72	-0.665	-0.605	V	-
$V_{OCPBD(BS2)}$	Bottom-Skip Operation Threshold Voltage2	7 - 3	-0.485	-0.435	-0.385	V	-
$V_{OCPBD(LIM)}$	Overcurrent Detection Threshold Voltage	7 - 3	-0.995	-0.94	-0.895	V	-
$I_{OCPBD}$	OCP/BD Pin Outflow Current	7 - 3	-250	-100	-40	μA	-
$V_{OCPBD(TH1)}$	Quasi-Resonant Operation Threshold Voltage 1	7 - 3	0.28	0.4	0.52	V	-
$V_{OCPBD(TH2)}$	Quasi-Resonant Operation Threshold Voltage 2	7 - 3	0.67	0.8	0.93	V	-
$V_{FB(OFF)}$	FB Pin Threshold Voltage	6 - 3	1.32	1.45	1.58	V	-
$I_{FB(ON)}$	FB Pin Inflow Current (Normal Operation)	6 - 3	600	1000	1400	μA	-

# IRIS-W6756

## Electrical Characteristics (for Control IC), Cont'd.

Stand-by Operation							
$V_{CC(S)}$	Stand-by Operation Start Voltage	4 - 3	10.3	11.1	12.1	V	$V_{CC}=0 \rightarrow 12.2V$
$V_{CC(SK)}$	Stand-by Operation Start Voltage Interval	4 - 3	1.1	1.35	1.65	V	-
$I_{CC(S)}$	Stand-by Non-Operation Circuit Current	4 - 3	-	20	56	$\mu A$	$V_{CC}=10.2V$
$I_{FB(S)}$	FB Pin Inflow Current (Stand-by)	6 - 3	-	4	14	$\mu A$	$V_{CC}=10.2V$
$V_{FB(S)}$	Stand-by Operation FB Pin Threshold Voltage	6 - 3	0.55	1.1	1.5	V	$V_{CC}=12.2V$
$T_{ON(MIN)}$	Minimum ON Time	1 - 3	0.65	1.0	1.35	$\mu Sec$	-
Protection Operation							
$T_{ON(MAX)}$	Maximum ON Time	1 - 3	27.5	32.5	39	$\mu Sec$	-
$V_{SSOLP(OLP)}$	OLP Operation Threshold Voltage	5 - 3	4	4.9	5.8	V	-
$I_{SSOLP(OLP)}$	OLP Operation Charging Current	5 - 3	-16	-11	-6	$\mu A$	-
$V_{CC(OVP)}$	OVP Operation Voltage	4 - 3	25.5	27.7	29.9	V	$V_{CC}=0 \rightarrow 29.9V$
$I_{CC(H)}$	Latch Circuit Holding Current *5	4 - 3	--	45	140	$\mu A$	$V_{CC}=29.9 \rightarrow V_{CC(OFF)}-0.3V$
VCC(La.OFF)	Latch Circuit Release Voltage *5	4 - 3	6	7.2	8.5	V	$V_{CC}=29.9 \rightarrow 6V$

\*5 The latch circuit means a circuit operated O.V.P and O.L.P.

\*6 The current ratings are based on those of the IC , and plus(+) represents sink and minus(-) represents source.

Electrical characteristics for MOSFET (Ta=25 deg C)

Symbol	Definition	Terminals	Ratings			Units	Note
			MIN	TYP	MAX		
V <sub>DSS</sub>	Drain-to-Source breakdown voltage	1 - 3	650	-	-	V	I <sub>D</sub> =300μA
I <sub>DSS</sub>	Drain leakage current	1 - 3	-	-	300	μA	V <sub>DS</sub> =650V
R <sub>DS(ON)</sub>	On-resistance	1 - 3	-	-	0.73	Ω	I <sub>D</sub> =2.2A
t <sub>f</sub>	Switching time	1 - 3	-	-	400	nSec	-
θ ch-F	Thermal resistance	-	-	-	1.5	°C/W	Between channel and internal frame

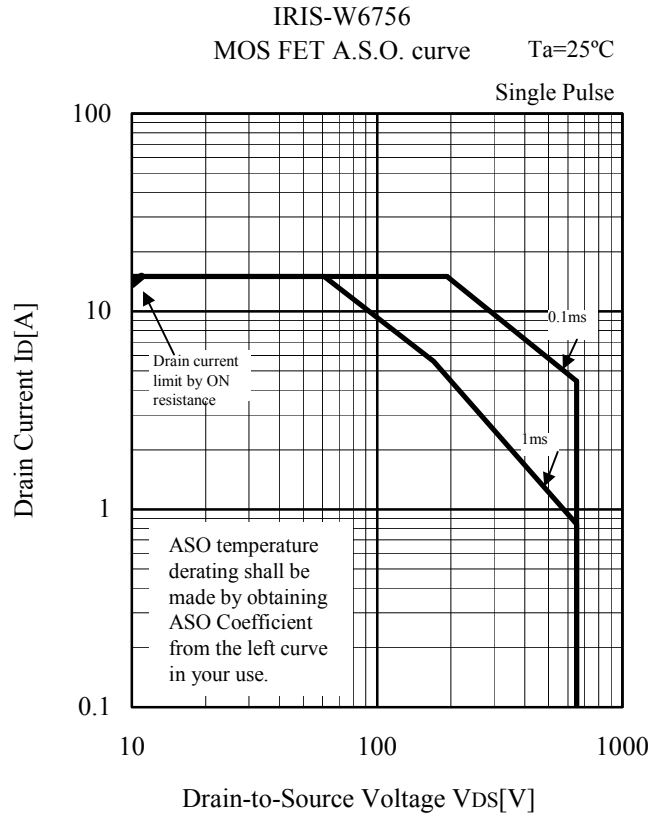
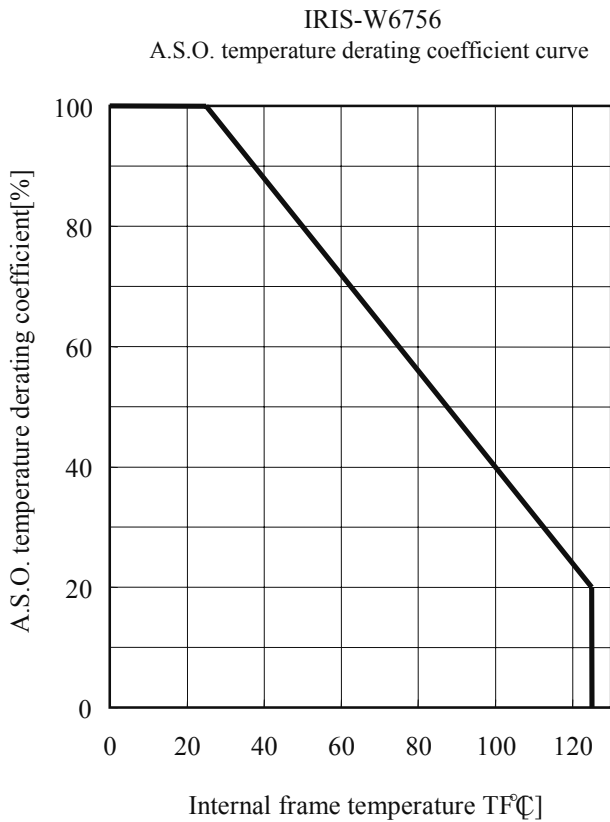

# IRIS-W6756

IRIS-W6756  
MOSFET Ta-PD1 Curve

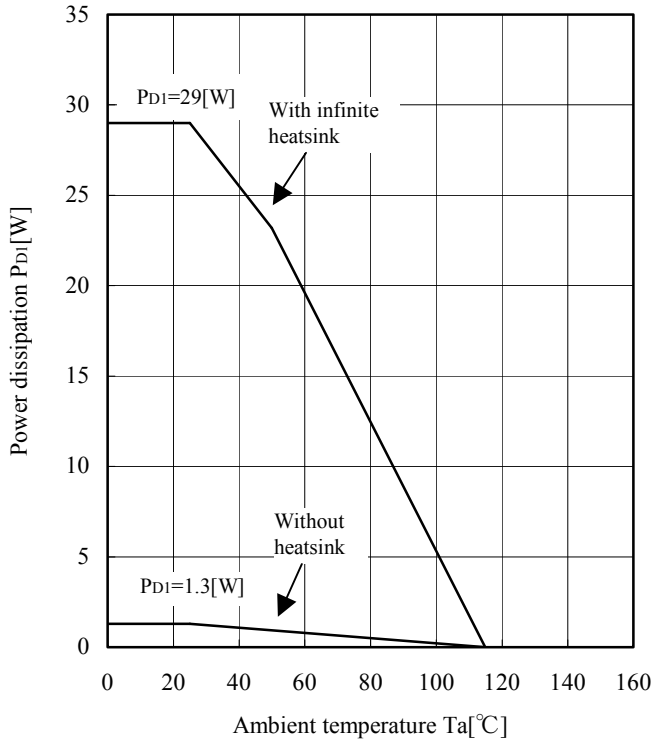

IRIS-W6756  
Avalanche energy derating curve

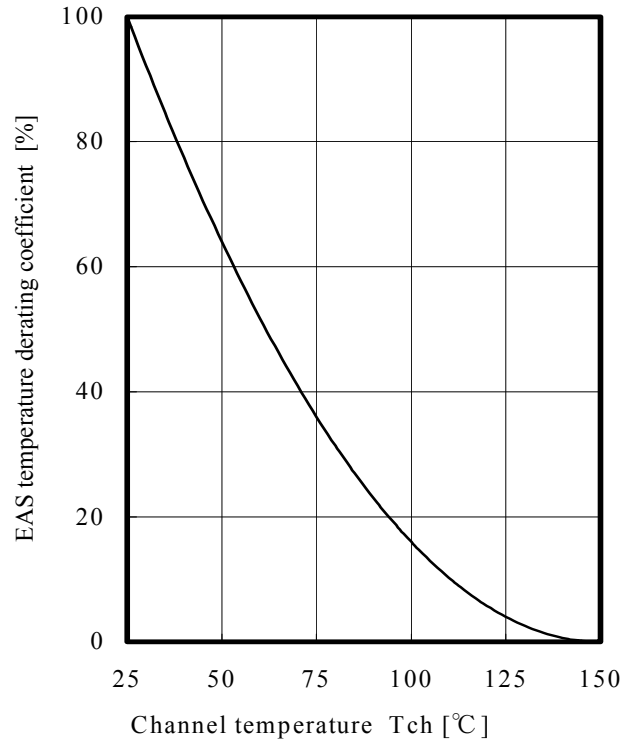

IRIS-W6756  
Transient thermal resistance curve

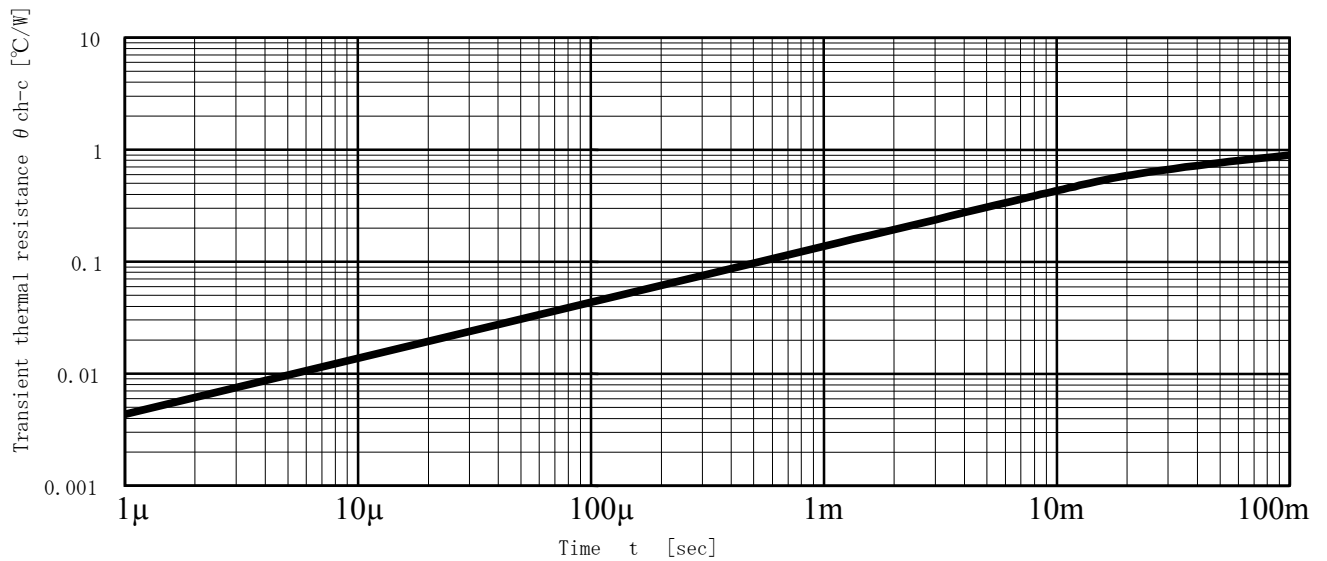

Block Diagram

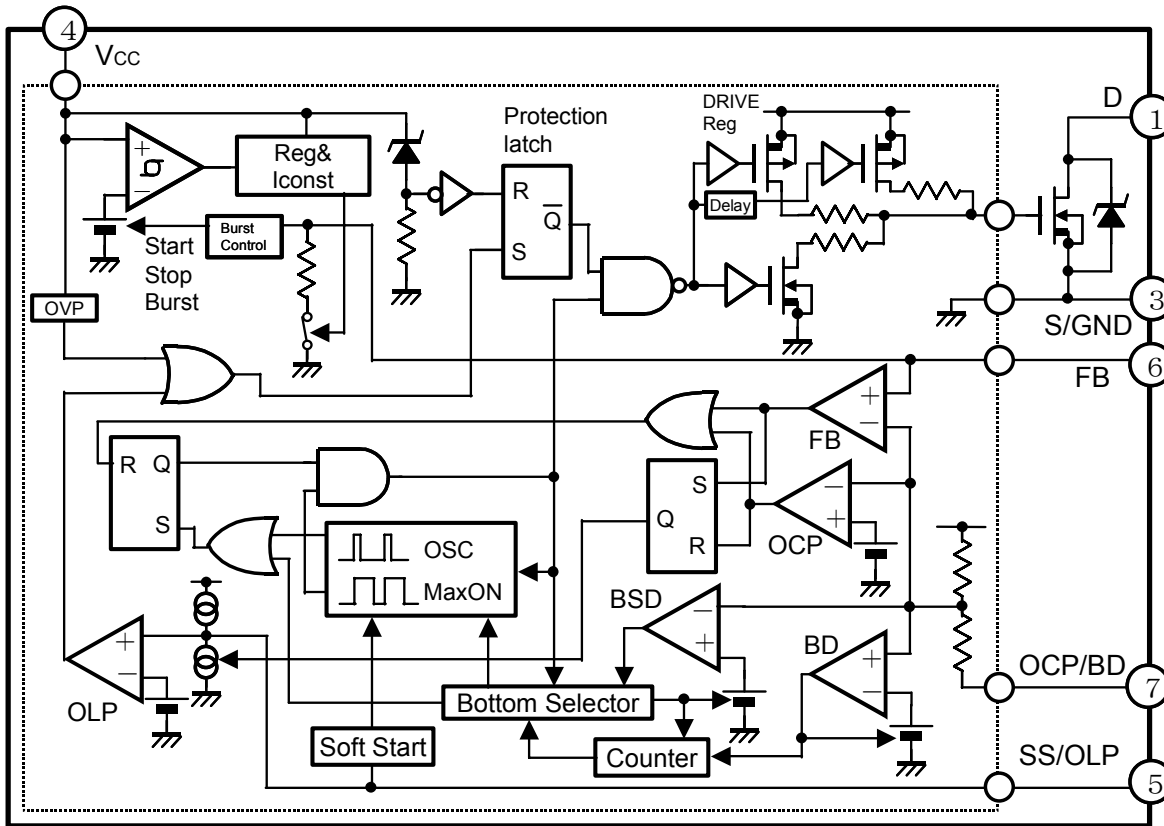

**Pin Designation**

Pin Assignments	Pin No.	Symbols	Descriptions	Functions
	1	D	Drain pin	MOSFET drain
	3	S/GND	Source /Ground pin	MOSFET Source / Ground
	4	VCC	Power supply pin	Input of power supply for control circuit
	5	SS/OLP	Delay at Overload /Soft Start set up Pin	Overload Protection and Soft Start Operation Time set up
	6	FB	Feedback pin	Constant Voltage Control Signal Input, Burst(intermittent) mode Oscillation Control
	7	OCP/BD	Overcurrent Protection Input / Bottom Detection Pin	Overcurrent Detection Signal Input /Bottom Detection Signal Input

# IRIS-W6756

## Case Outline

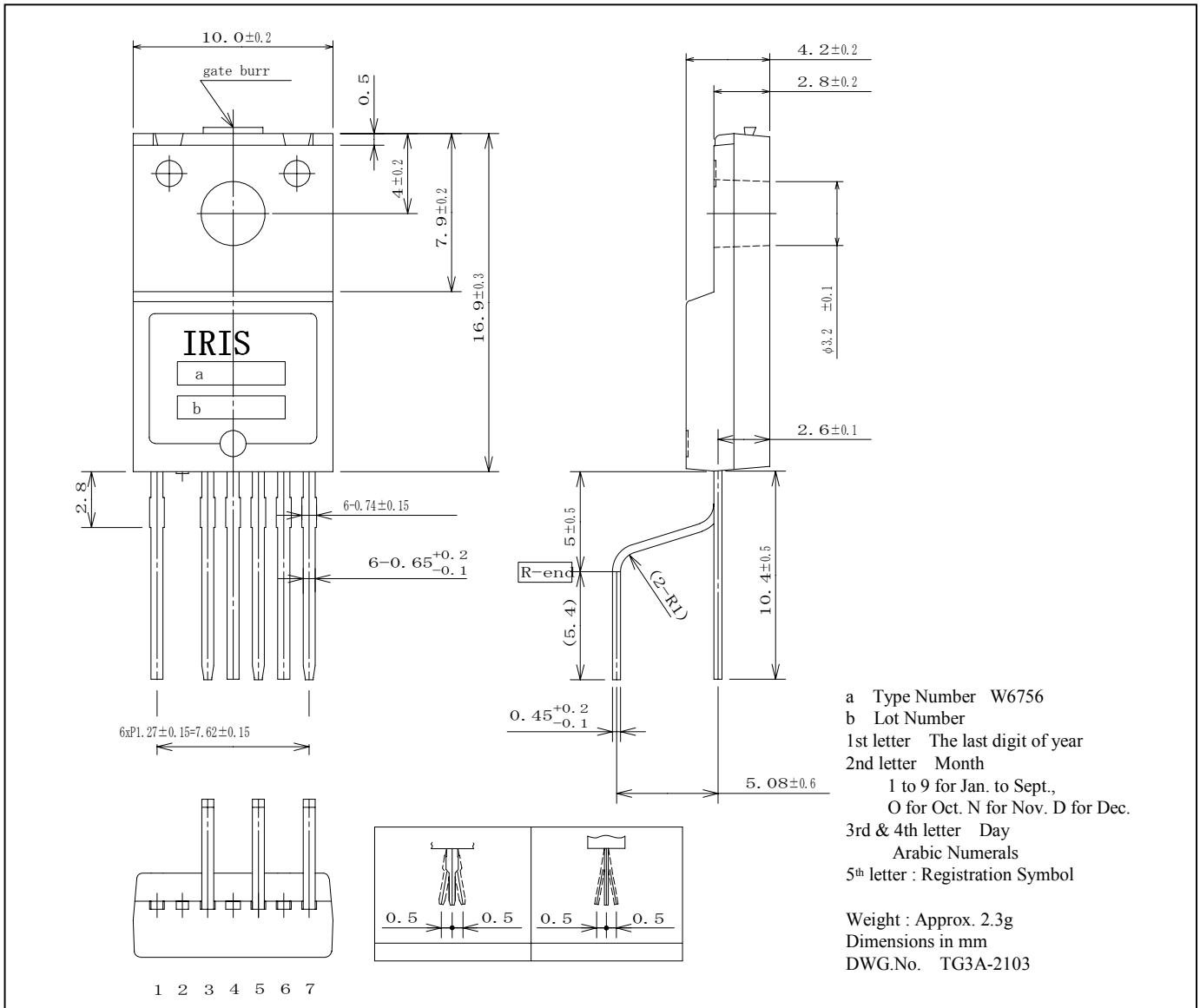

a Type Number W6756  
 b Lot Number  
 1st letter The last digit of year  
 2nd letter Month  
 1 to 9 for Jan. to Sept.,  
 O for Oct. N for Nov. D for Dec.  
 3rd & 4th letter Day  
 Arabic Numerals  
 5th letter : Registration Symbol

Weight : Approx. 2.3g  
 Dimensions in mm  
 DWG.No. TG3A-2103

Material of Pin : Cu  
 Treatment of Pin : Ni plating + solder dip

Data and specifications subject to change without notice.



IR WORLD HEADQUARTERS: 233 Kansas St., El Segundo, California 90245, USA Tel: (310) 252-7105

TAC FAX: (310) 252-7903

Visit us at [www.irf.com](http://www.irf.com) for sales contact information.

[www.irf.com](http://www.irf.com)